

# **Инструкция**

## **Баттерфляй Body Solid ProClub SPD-700G**

Полезные ссылки:







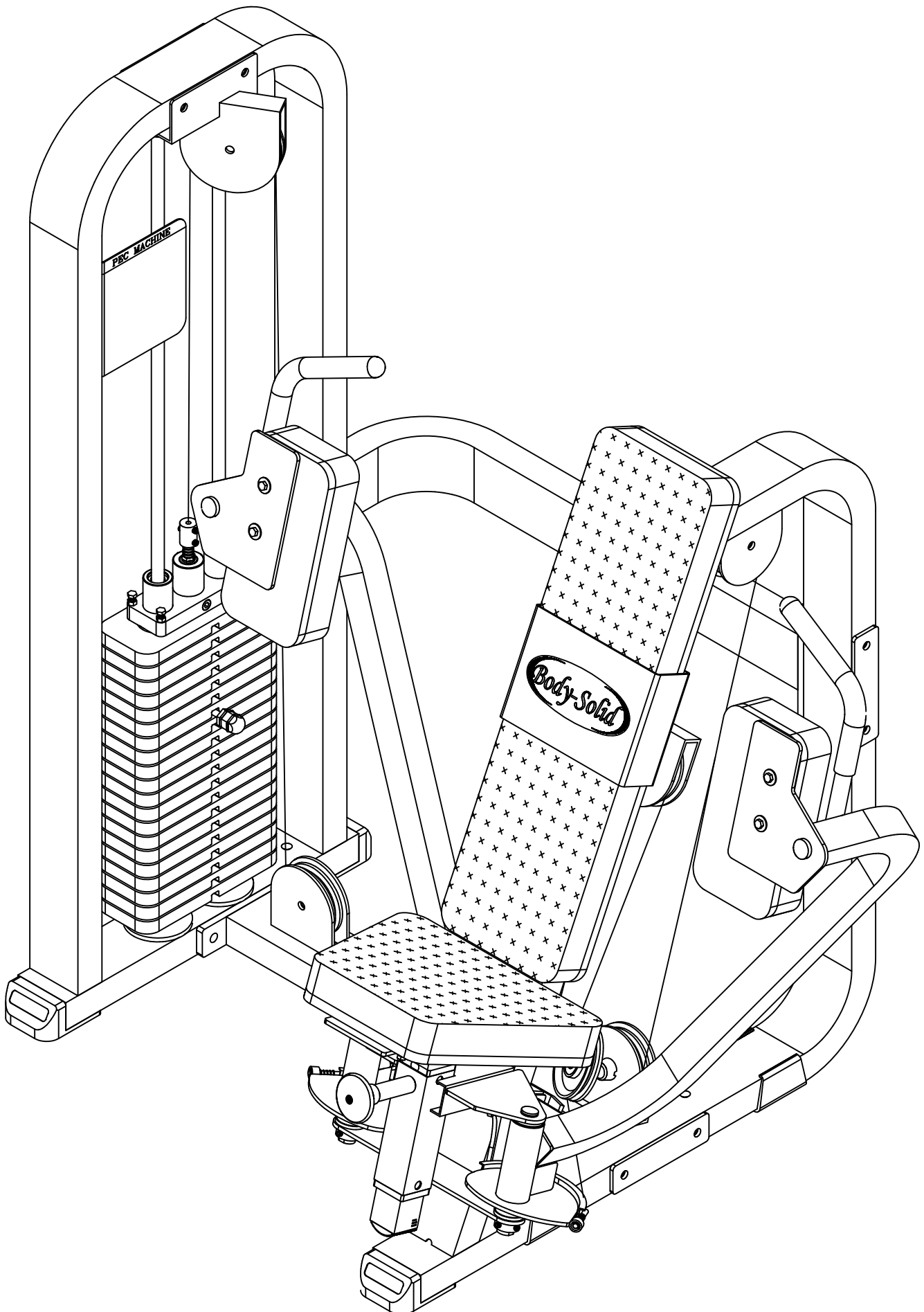



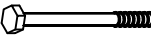
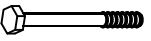





[Баттерфляй Body Solid ProClub SPD-700G - смотреть на сайте](#)

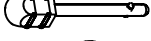













[Баттерфляй Body Solid ProClub SPD-700G - читать отзывы](#)

SPD-700G  
PEC MACHINE



VERSION 0705

	Qty.
 A2. 1/2"X5 1/2" HEX HEAD BOLT -----[6PCS]	
 A3. 1/2"X5" HEX HEAD BOLT -----[2PCS]	
 A4. 1/2"X3 1/2" HEX HEAD BOLT -----[2PCS]	
 A5. 1/2"X2 1/4" HEX HEAD BOLT -----[5PCS]	
 A6. 1/2"X2" HEX HEAD BOLT -----[2PCS]	
 A7. 5/16"X3" HEX HEAD BOLT -----[2PCS]	
 A8. 5/16"X1 1/4" HEX HEAD BOLT ---[8PCS]	
 A9. 7/16"X1 1/2" ROUND BOLT -----[1PCS]	
 A10. 5/16"X3/8" SET SCREW -----[3PCS]	
 A11. 5/8" ROUND BOLT -----[1PCS]	
 A12. 10LB BALL PIN -----[1PCS]	
 B1. 1/2" NYLON LOCK NUT -----[18PCS]	
 B2. 5/8" LOCK NUT -----[1PCS]	
 B3. 3/8" LOCK NUT -----[4PCS]	
 C1. 1/2" ROUND END CAP WASHER --[34PCS]	
 C3. 5/16" (I.D)WASHER -----[10PCS]	
 C4. 5/16" SPRING WASHER -----[10PCS]	
 C5. 5/8" SPRING WASHER -----[1PCS]	

	Qty.
 D1. 1/2" BOLT CAP -----[34PCS]	
 D2. 2"X4" END CAP (9211-014)-----[1PCS]	
 D3. 2"X4" FOOT END CAP (9211-028)---[3PCS]	
 D4. 2"X4" RUBBER DOUNT (9212-009)---[3PCS]	
 D7. ø4" RUBBER DONUT (9310-017)----[2PCS]	
 D8. ø6" PULLEY (9213-009)-----[1PCS]	
 D9. ø4 1/2" PULLEY (9213-010)-----[6PCS]	
 D10. CHROME TOP PLATE (8400-002)---[1PCS]	
 D11. WEIGHT SELECTOR BAR (8220-060)-[1PCS]	
 D12. 4545mm STEEL CABLE -----[1PCS]	
 D14. 1650mm STEEL CABLE -----[1PCS]	
 D15. ø5/8" ROUND END CAP (9211-015)-[4PCS]	
 D16. ø3/4" SHAFT COLLAR (9211-046)---[2PCS]	
 D17. 50X50X1.8t END CAP (9211-087)---[1PCS]	
 D18. 60X50 NYLON BUSHING (9211-033)-[2PCS]	

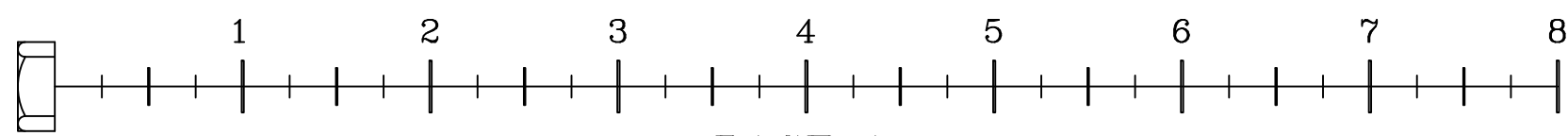
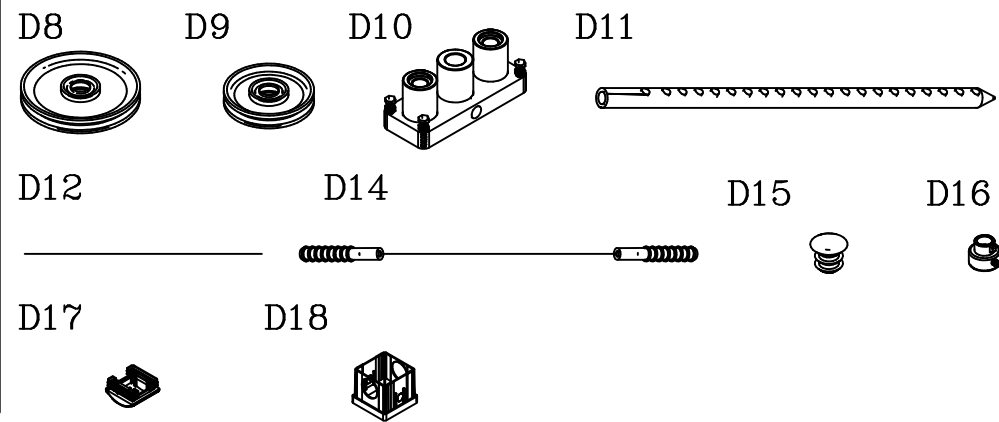

A [1PCS] WEIGHT STACK FRAME

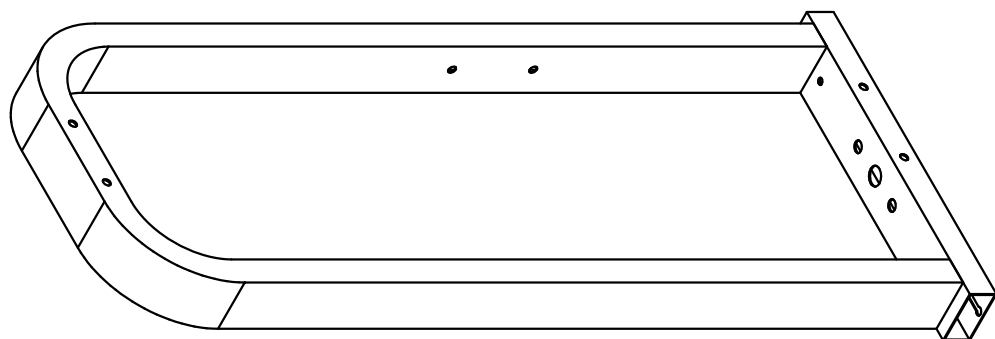

D-2 [1PCS] MAIN BODY FRAME

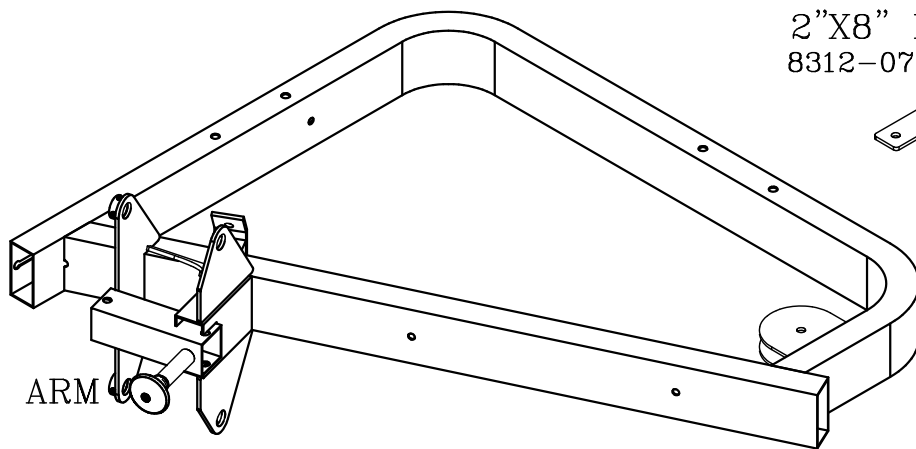

K [4PCS]  
2"X8" PLATE  
8312-077

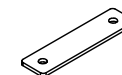

B [1PCS] MIDDLE SUPPORT FRAME

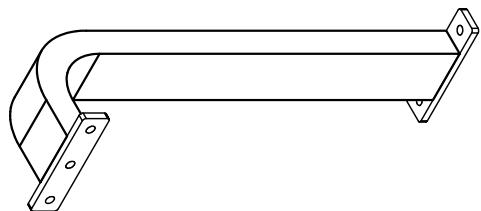

E-1 [1PCS] RIGHT PEC ARM

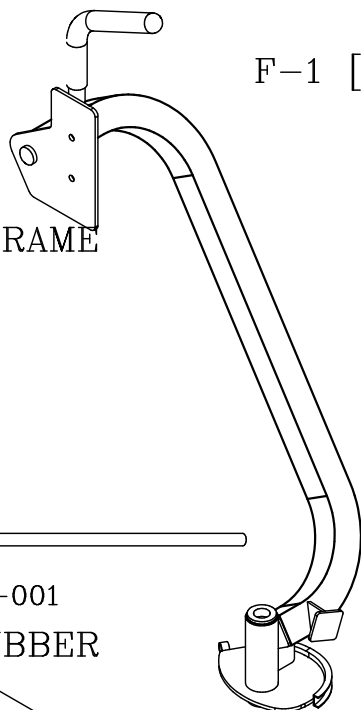

F-1 [1PCS] LEFT PEC ARM

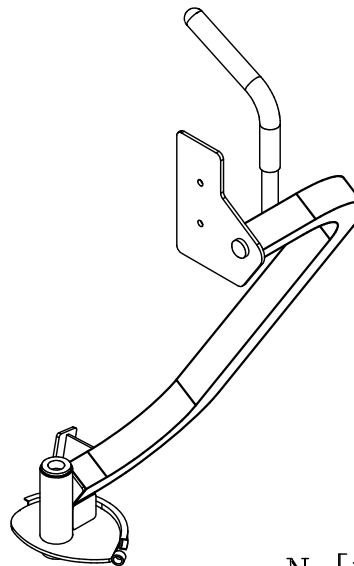

I [1PCS]  
TOP PULLEY FRAME

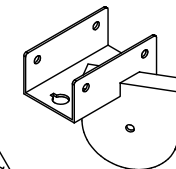

C-1 [1PCS] BOTTOM PULLEY FRAME

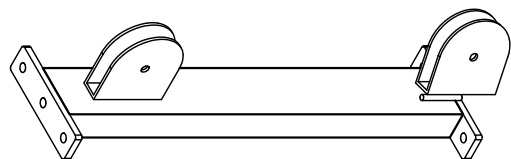

L [1PCS] BACK PAD  
9111-018

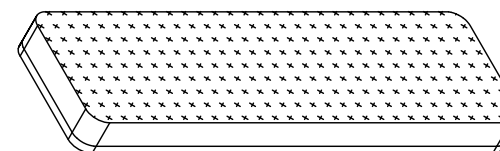

J [2PCS] CHROME GUIDE ROD

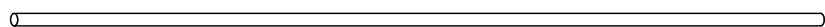

M [1PCS]  
SEAT PAD  
9121-016

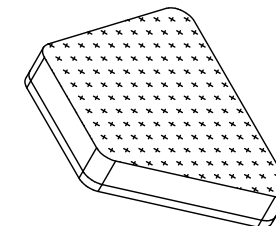

P [2PCS]  
8331-015

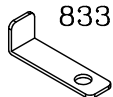

Q [1PCS] 9119-001  
BACK PAD RUBBER

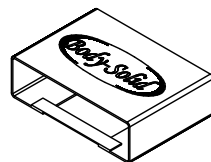

H [1PCS]  
SINGLE PULLEY HOLDER



R [1PCS]

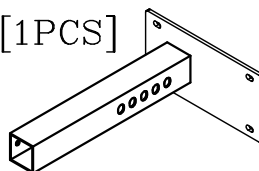

N [1PCS] 9131-010  
RIGHT PEC PAD

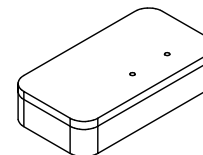

O [1PCS] 9131-009  
LEFT PEC PAD

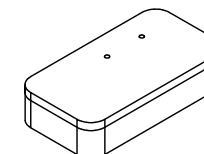

# SPD-700G

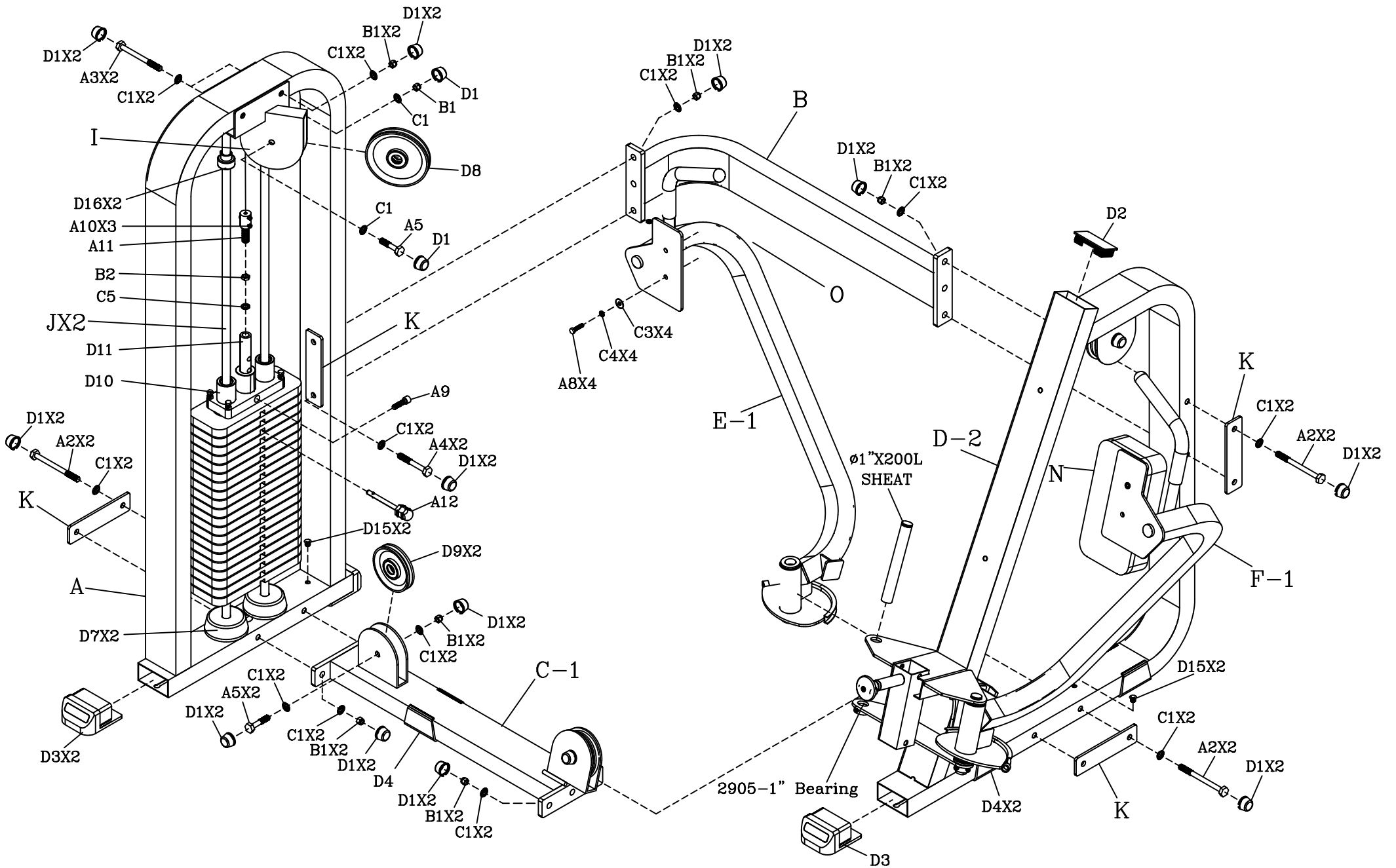

# SPD-700G

THERE IS A RISK ASSUMED BY INDIVIDUALS WHO USE THIS TYPE OF EQUIPMENT. TO MINIMIZE RISK, YOU MUST FOLLOW THESE RULES:

1. Inspect equipment before each workout. Check that all nuts, bolts, screws and pop pins are in place and fully tightened. Also, before use, check cables for signs of wear. Replace all worn parts immediately. Never use machine if any parts are damaged or missing. Failure to follow these rules may result in serious injury.
2. Keep clear of the cables and all moving parts when the machine is in use.
3. Always make sure all Snap Links are closed when doing any cable/pulley exercises.
4. Exercise with care. Perform your exercises at a smooth moderate pace; never perform jerky or uncoordinated movements that may cause injury.
5. It is recommended that you should workout with a training partner.
6. Do not allow children or minors to play on or around this equipment.
7. If unsure of proper use of equipment, call your local Body-Solid distributor or the Body-Solid customer service department at 1-800-556-3113.
8. **WARNING:** Consult your physician before starting your exercise program. For your own safety, do not begin any exercise program without proper instruction.

RAL2-11-98

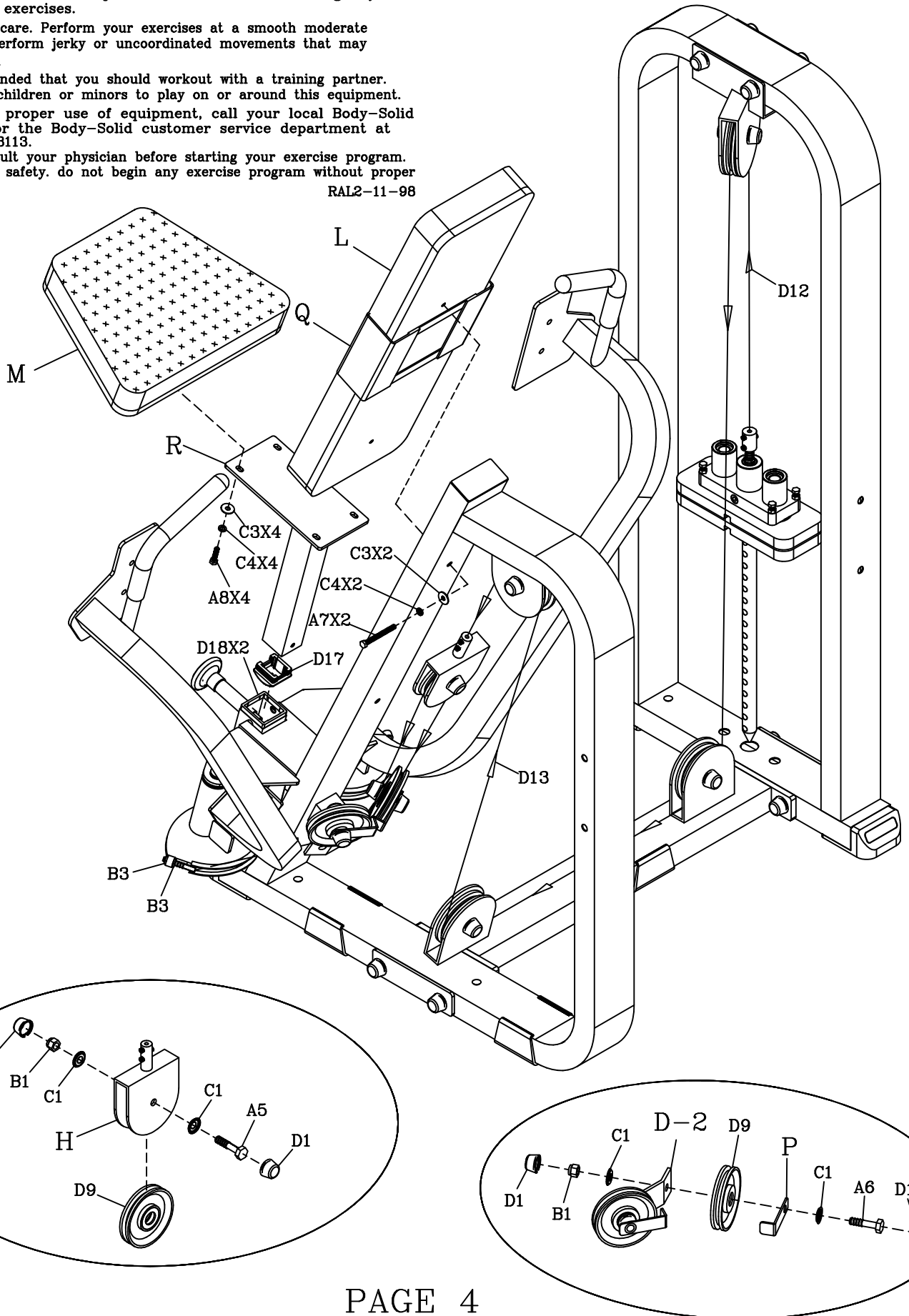

# SPD-700G PEC MACHINE ASSEMBLY STEPS

## STEP-1

NOTE: DO NOT TIGHTEN AND BOLTS SECUREY UNTIL.  
YOU HAVE COMPLETED ALL ASSEMBLY STEPS.

- Attach A Weight Stack Frame to C Bottom Pulley Frame.
- Attach D Main Body Frame to C Bottom Pulley Frame using H Single Pulley Holder.
- Attach B Middle Support Frame to A Weight Stack Frame and D Main Body Frame.
- Attach E and F Pec arms to D Main Body Frame.

## STEP-2

- Attach L Back Pad and M Seat Pad to D Main Body Frame.
- Attach O and N Pec Pads to E and F Pec Arms.
- Attach J Chrome Guide Rods and D7 Rubber Donuts to A Weight Stack Frame.
- Slide Weight Stack and D10 Chrome Top Plate onto J Chrome Guide Rods.
- Attach I Top Pulley Frame to A Weight Stack Frame and attach D16 Shaft Collar.

CAUTION: DO NOT OVERTIGHTEN PAD BOLTS.  
OVERTIGHTENING WILL STRIP

## STEP-3 T-NUTS IN THE WOOD.

- Attach Pulleys and Cables as shown.
- Attach End Caps, Grips and Stopprs.
- TIGHTEN ALL NUTS AND BOLTS SECURELY.
- Attach Bolt Caps.

### SAFETY RULES

1. Periodically check that all nuts, bolts and screws are fully tightened on your CHEST PRESS MACHINE.
2. Exercise with care. Perform your exercises at a smooth moderate pace; never perform jerky or uncoordinated movements that may cause injury.
3. It is recommended that you should workout with a training partner.
4. Warning: CONSULT YOUR PHYSICIAN BEFORE STARTING YOUR EXERCISE PROGRAM. IT IS ADVISABLE TO HAVE A PHYSICAL EXAMINATION BEFORE YOU ENTER ANY EXERCISE PROGRAM. FOR YOUR OWN SAFETY, DO NOT BEGIN ANY EXERCISE WITHOUT PROPER INSTRUCTION.

# SPD-700G PEC MACHINE

