

## **Инструкция**

### **Баттерфляй/Задняя дельта Body Solid S2PEC-1**

Полезные ссылки:

[Баттерфляй/Задняя дельта Body Solid S2PEC-1 - смотреть на сайте](#)

[Баттерфляй/Задняя дельта Body Solid S2PEC-1 - читать отзывы](#)

*Body-Solid*®  
Built for Life

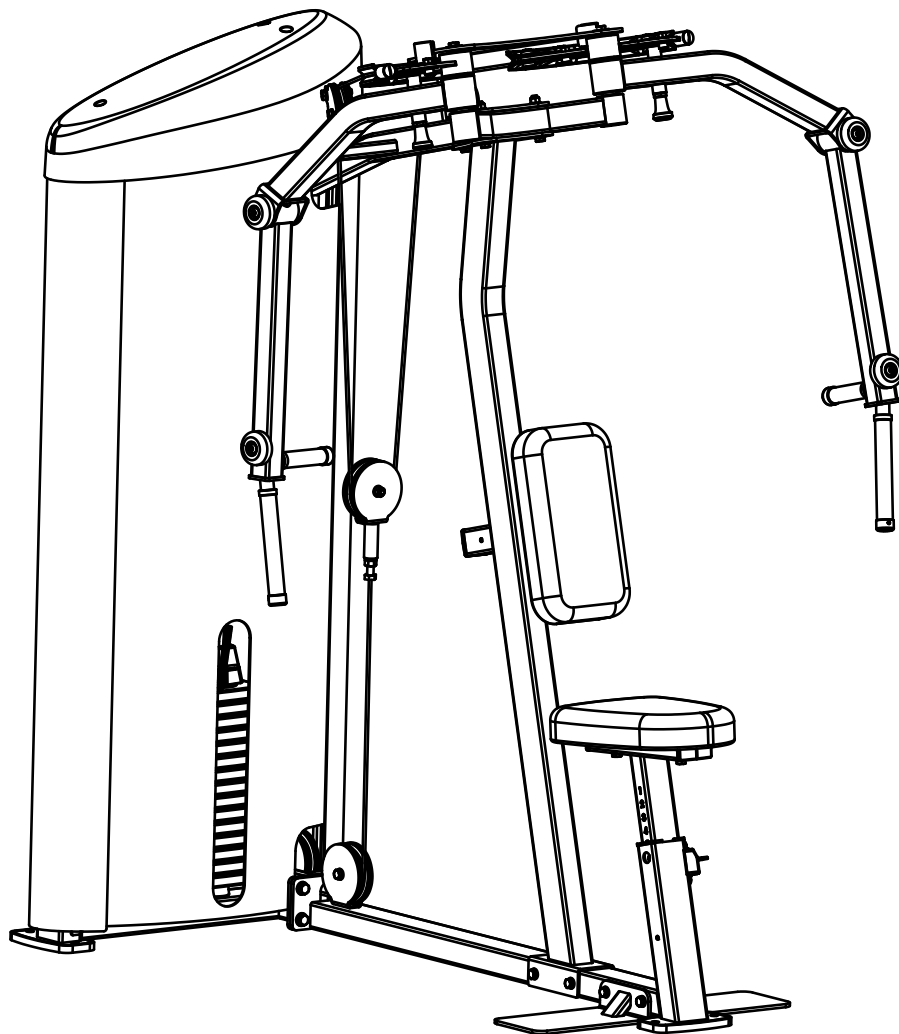

**S2PEC**

Assembly & Instructions  
**OWNER'S & MANUAL**

v. S2LPEC-082812

# Warning, Safety & Maintenance

Be sure that all users carefully read and understand all warning, safety and maintenance labels on the machine before each use. Failure to do so may result in death or serious injury.

It is imperative that you retain this Owner's Manual and be sure all warning labels are legible and intact. Replacement Owner's Manuals and warning labels are available from your local Body-Solid dealer.

If you have any questions about the operation, set up or maintenance of this machine please call our customer service department at 1 (800) 556-3113.

**THERE IS A RISK ASSUMED BY INDIVIDUALS WHO USE THIS TYPE OF EQUIPMENT. TO MINIMIZE RISK, YOU MUST FOLLOW THESE RULES:**

1. Inspect equipment before each workout. Check that all nuts, bolts, screws and pop pins are in place and fully tightened. Also, before use, check cables for signs of wear. Replace all worn parts immediately. Never use machine if any parts are damaged or missing.  
**FAILURE TO FOLLOW THESE RULES MAY RESULT IN SERIOUS INJURY.**
2. Keep clear of the cables and all moving parts when the machine is in use.
3. Always make sure all Snap Links are closed when doing any cable/pulley/strap exercises.
4. Exercise with care. Perform your exercises at a smooth moderate pace; never perform jerky or uncoordinated movements that may cause injury.
5. It is recommended that you should workout with a training partner.
6. Do not allow children or minors to play on or around this equipment.
7. If unsure of proper use of equipment, call your local Body-Solid distributor or the Body-Solid customer service department at 1-800-556-3113.
8. **WARNING:** Consult your physician before starting your exercise program. For your own safety, do not begin any exercise program without proper instruction. RAL8-6-03 WC-54

## WARNING

### Safety and Maintenance of Cables

**IMPORTANT:** Cables are wear items. It is your responsibility to prevent unexpected breakage. **Cable inspection should be performed daily.** Inspect all cables, the nylon coating on all cables, and the area near the fitting at each end of each cable. **Replace any damaged or worn cable immediately.** Do not allow the machine to be used until damaged or worn cables are replaced. Using or allowing a machine to be used with a suspect cable can result in serious injury. See Owner's Manual for more information.

For Body-Solid Customer Service  
**Call 1-800-556-3113**

<b>MAINTENANCE SCHEDULE</b>		D A I L Y	W E E K L Y
Check the function and integrity of the following components. As noted, inspect equipment before each workout. Replace all damaged, broken or worn components immediately.			
Cables:	Check tension, end fittings, and coating	✓	
	Check that locking nut at weight stack is tight		✓
Upholstery:	Wipe down and dry	✓	
	Clean and condition		✓
Frame:	Wipe down and dry	✓	
	Polish / Wax		✓
Chrome:	Wipe down and dry	✓	
	Polish / Lubricate		✓
Nuts / Bolts / Fasteners:	Tighten and / or adjust as needed		✓
Guide Rods:	Lubricate and clean		✓
Linear Rods:	Lubricate and clean		✓
Seat Sleeves:	Lubricate and clean		✓
Adjustments / Locking Pins / Tightening Knobs			✓
Weight Stack Pins			✓
Warning Instruction Labels			✓
Springs / Pop Pins		✓	
Anti Skid Surfaces			✓
Hand Grips / Rollers			✓

For Body-Solid Customer Service  
**Call 1-800-556-3113**  
#MSSTKR0803

## Table of Contents

- SAFETY INSTRUCTIONS..... PAGE 4
- PREPARATION..... PAGE 5
- HARDWARE LIST..... PAGE 6
- HARDWARE ILLUSTRATION..... PAGE 8
- PART / LIST ILLUSTRATION..... PAGE 12
- ASSEMBLY INSTRUCTIONS..... PAGE 22
- EXPLODED VIEW..... PAGE 35
- CONTACT PAGE..... PAGE 36

# Important Safety Instructions

Before beginning any fitness program, you should obtain a complete physical examination from your physician.

*Il est conseillé de subir un examen médical complet avant d'entreprendre tout programme d'exercice.  
Si vous avez des étourdissements ou des faiblesses, arrêtez les exercices immédiatement.*

*Antes de comenzar cualquier programa de ejercicios, deberías tener un examen físico con su doctor.*

## **When using exercise equipment, you should always take basic precautions, including the following:**

- Read all instructions before using the **S2PEC**. These instructions are written to ensure your safety and to protect the unit.
- **Do not remove any safety labels from the machine.**
- Do not allow children on or near the equipment.
- Use the equipment only for its intended purpose as described in this guide. Do not use accessory attachments that are not recommended by the manufacturer. Such attachments might cause injuries.
- Wear proper exercise clothing and shoes for your workout, no loose clothing.
- Keep hands, limbs, loose clothing, and long hair well out of the way of all moving parts.
- Use care when getting on or off the unit.
- Do not overexert yourself or work to exhaustion.
- If you feel any pain or abnormal symptoms, stop your workout immediately and consult your physician.
- Never operate unit when it has been dropped or damaged. Return the equipment to a service center for examination and repair.
- Never drop or insert objects into any opening in the equipment.
- Always check the unit and its cables before each use. Make sure that all fasteners and cables are secure and in good working condition.
- Do not use the equipment outdoors or near water.

## **Personal Safety During Assembly**

- Before beginning assembly, please take the time to read the instructions thoroughly.
- Read each step in the assembly instructions and follow the steps in sequence. Do not skip ahead. If you skip ahead, you may learn later that you have to disassemble components and that you may have damaged the equipment.
- Assemble and operate the **S2PEC** on a solid, level surface. Locate the unit a few feet from the walls or furniture to provide easy access.

The **S2PEC** is designed for your enjoyment. By following these precautions and using common sense, you will have many safe and pleasurable hours of healthful exercise with your Body-Solid **Pec Fly / Rear Delt Machine**.

After assembly, you should check all functions to ensure correct operation. If you experience problems, first recheck the assembly instructions to locate any possible errors made during assembly. If you are unable to correct the problem, call the dealer from whom you purchased the machine or call **1-800-556-3113** for the dealer nearest you.

## **Obtaining Service**

Please use this Owner's Manual to make sure that all parts have been included in your shipment. When ordering parts, you must use the part number and description from this Owner's Manual. Use only Body-Solid replacement parts when servicing this machine. Failure to do so will void your warranty and could result in personal injury.

For information about product operation or service, check out the official Body-Solid website at [www.bodysolid.com](http://www.bodysolid.com) or contact an authorized Body-Solid dealer or a Body-Solid factory-authorized service company or contact Body-Solid customer service at one of the following:

**Toll Free: 1-800-556-3113**  
**Phone: 1-708-427-3555**  
**Fax: 1-708-427-3556**  
**Hours: M-F 8:30-5:00 CST**  
**E-Mail: [service@bodysolid.com](mailto:service@bodysolid.com)**

**Or write to: Body-Solid, Inc.**  
**Service Department**  
**1900 S. Des Plaines Ave.**  
**Forest Park, IL 60130 USA**

**Retain this Owner's Manual for future reference. If you need to order replacement parts please be prepared to provide the following information when contacting us so that we can assist you better.**

- 1. Model Number**
- 2. Place of Purchase**
- 3. Serial Number (S/N)**
- 4. Part # and Description**

# Preparation

Thank you for purchasing the **S2PEC**. This bench is part of the Body-Solid line of quality strength training machines, which lets you target specific muscle groups to achieve better muscle tone and overall body conditioning. To maximize your use of the equipment please study this Owner's Manual thoroughly.

## Required Tools

The basic tools that you must obtain before assembling the **S2PEC** include but are not limited to:

- Metric Allen Key Set
- Standard Allen Key Set
- Standard Wrench Set
- Metric Wrench Set
- Adjustable Wrench
- Screwdriver (standard and/or phillips)

## Installation Requirements

Follow these installation requirements when assembling the **S2PEC**:

Set up the **S2PEC** on a solid, flat surface. A smooth, flat surface under the machine helps keep it level. A level machine has fewer malfunctions.

Provide ample space around the machine. Open space around the machine allows for easier access.

Insert all bolts in the same direction. For aesthetic purposes, insert all bolts in the same direction unless specified (in text or illustrations) to do otherwise.

Leave room for adjustments. Tighten fasteners such as bolts, nuts, and screws so the unit is stable, but leave room for adjustments. Do not fully tighten fasteners until instructed in the assembly steps to do so.

**Fill out and mail the warranty card.**

## Assembly Tips

Read all "Notes" on each page before beginning each step.

While you may be able to assemble the **S2PEC** using the illustrations only, important safety notes and other tips are included in the text.

Some pieces may have extra holes that you will not use. Use only those holes indicated in the instructions and illustrations.

**NOTE:** With so many assembled parts, proper alignment and adjustment is critical. While tightening the nuts and bolts, be sure to leave room for adjustments.

**NOTE:** The bottles that are marked "Poison" is your touch up paint. Keep away from children.

**CAUTION:** Obtain assistance! If you feel like you can't assemble the **S2PEC** by yourself then do not attempt to do so as this could result in injury. Review the installation requirements before proceeding with the following steps.

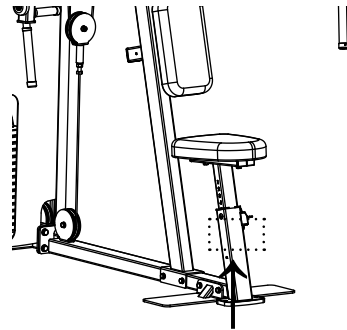

Your S/N# can  
be found here

Body-Solid continually seeks ways to improve the performance, specifications and product manuals in order to ensure that only superior products are released from our factories. Please take the time to carefully read through this manual thoroughly. Instructions contained in this document are not intended to cover all details or variations possible with Body-Solid equipment, or to cover every contingency that may be met in conjunction with installation, operation, maintenance or troubleshooting of the equipment. Even though we have prepared this manual with extreme care, neither the publisher nor the author can accept responsibility for any errors in, or omission from, the information given. Should additional information be required, or should situations arise that are not covered by this manual, the matter should be directed to your local Body-Solid representative, or the Service Department at Body-Solid Inc. in Forest Park, Illinois.

## S 2 P E C Hardware List

<b>Part#</b>	<b>Size</b>	<b>Description</b>	<b>Quantity</b>
1	M10X105mm	HEX HEAD BOLT	4 PCS.
2	M10X80mm	HEX HEAD BOLT	3 PCS.
3	M10X50mm	HEX HEAD BOLT	11 PCS.
4	M10X35mm	HEX HEAD BOLT	1 PCS.
5	M10X30mm	HEX HEAD BOLT	4 PCS.
6	M10X25mm	HEX HEAD BOLT	3 PCS.
7	M10X115mm	BUTTON HEAD CAP SCREW	2 PCS.
8	M10X30mm	BUTTON HEAD CAP SCREW	2 PCS.
9	M8X25mm	BUTTON HEAD CAP SCREW	12 PCS.
10	M8X20mm	SOCKET HEAD CAP SCREW	6 PCS.
11	M6X40mm	BUTTON HEAD CAP SCREW	2 PCS.
12	M8X8mm	SET SCREW	4 PCS.
13	M6X16mm	PHILLIPS HEAD SCREW	3 PCS.
14	M4X8mm	SET SCREW	1 PCS.
15	M12X35mm	HEX HEAD BOLT	4 PCS.
16	M5X16mm	FLAT PHILLIPS HEAD SCREW	4 PCS.
17	10-32X1/8"	SET SCREW	16 PCS.
18	3/8"X2"	SOCKET HEAD CAP SCREW	1 PCS.
40	M12	NYLON LOCK NUT	6 PCS.
41	M10	NYLON LOCK NUT	21 PCS.
42	M8	NYLON LOCK NUT	16 PCS.
43	M6	NYLON LOCK NUT	2 PCS.
44	1/2"-13	HEX NUT	2 PCS.
45	M10	RIVET NUT	2 PCS.
50	Φ13XΦ24X2.5mm	FLAT WASHER	10 PCS.

## S 2 P E C H a r d w a r e L i s t

<b>Part#</b>	<b>Size</b>	<b>Description</b>	<b>Quantity</b>
51	Φ11XΦ20X2mm	FLAT WASHER	46 PCS.
52	Φ9XΦ16X1.6mm	FLAT WASHER	20 PCS.
53	Φ6.6XΦ12X1.6mm	FLAT WASHER	3 PCS.
54	Φ11XΦ30X2mm	FLAT WASHER	3 PCS.
55	1/2"	SPRING WASHER	2 PCS.
56	Φ10	SPRING WASHER	4 PCS.
57	3/8"	SPRING WASHER	1 PCS.



# S2PEC Hardware Illustration

Part #1

HEX HEAD BOLT M10X105mm

QTY. 4

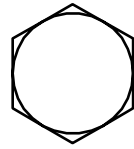
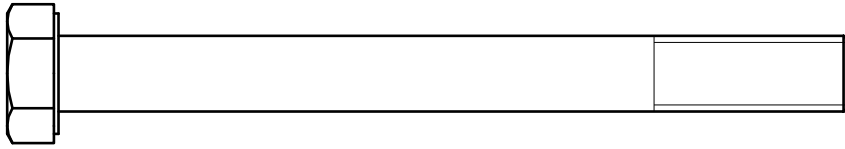

Part #2

HEX HEAD BOLT M10X80mm

QTY. 3

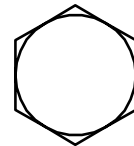
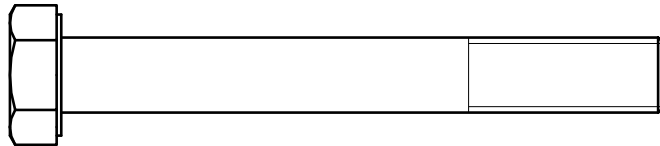

Part #3

HEX HEAD BOLT M10X50mm

QTY. 11

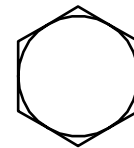
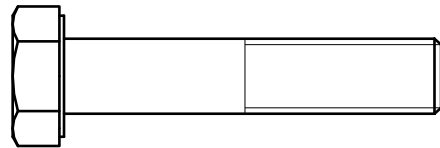

Part #4

HEX HEAD BOLT M10X35mm

QTY. 1

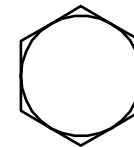
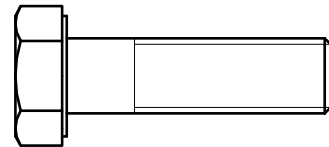

Part #5

HEX HEAD BOLT M10X30mm

QTY. 4

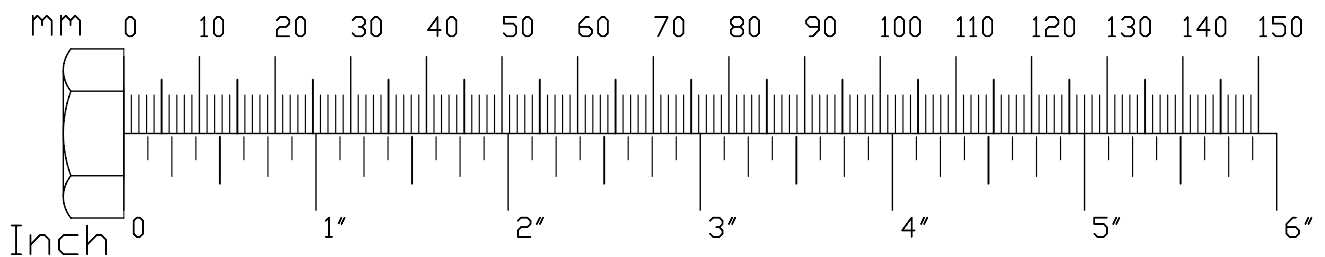
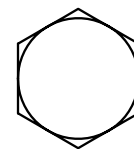
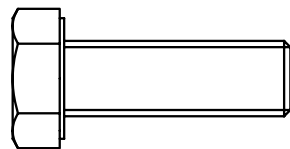

# S2PEC Hardware Illustration

Part #6

HEX HEAD BOLT M10X25mm

QTY. 3

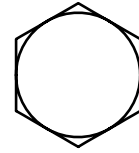
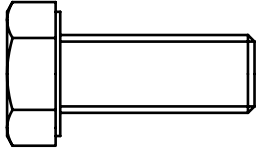

Part #7

BUTTON HEAD CAP SCREW M10X115mm

QTY. 2

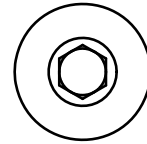
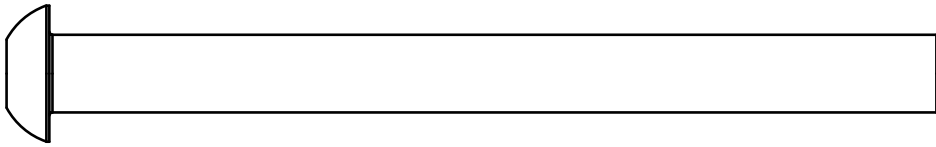

Part #8

BUTTON HEAD CAP SCREW M10X30mm

QTY. 2

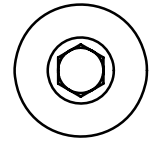
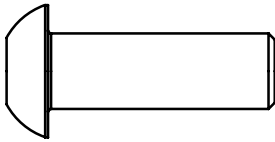

Part #9

BUTTON HEAD CAP SCREW M10X25mm

QTY. 12

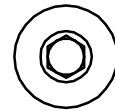
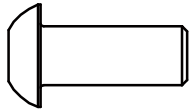

Part #10

SOCKET HEAD CAP SCREW M8X20mm

QTY. 6

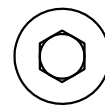
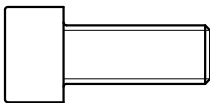

Part #11

BUTTON HEAD CAP SCREW M6X40mm

QTY. 2

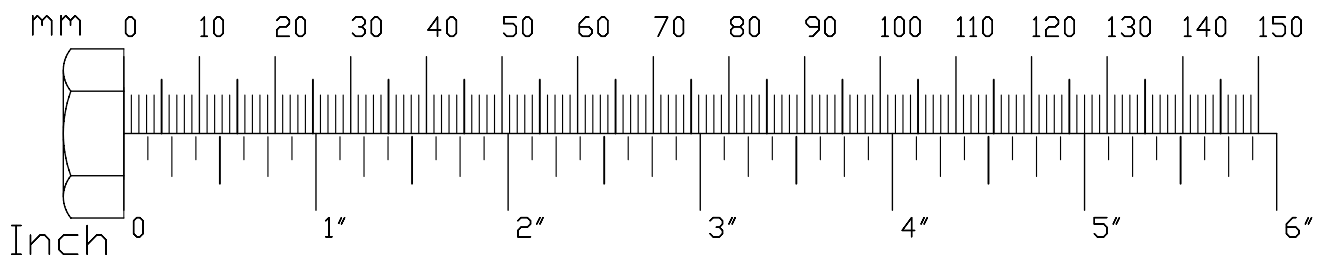
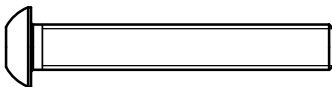

# S2PEC Hardware Illustration

Part #12                      SET SCREW M8X8mm                      QTY. 4



Part #13                      PHILLIPS HEAD SCREW M6X16mm                      QTY. 3

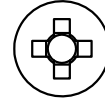
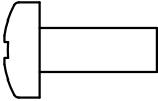

Part #14                      SET SCREW M4X8mm                      QTY. 1



Part #15                      HEX HEAD BOLT M8X8mm                      QTY. 4

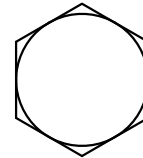
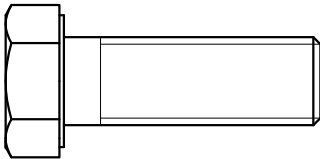

Part #16                      FLAT PHILLIPS SCREW M5X16mm                      QTY. 4

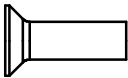

Part #17                      SET SCREW 10-32X1/8mm                      QTY. 16



Part #18                      SOCKET HEAD CAP SCREW 3/8"X2"                      QTY. 1

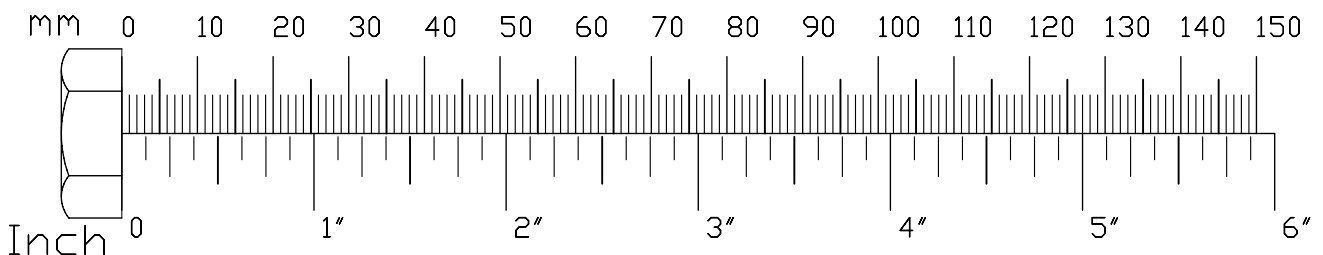
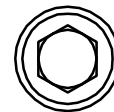
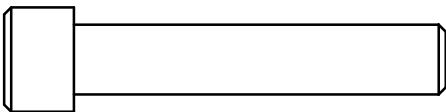

# S2PEC Hardware Illustration

Part #40

NYLON LOCK NUT M12

QTY. 6

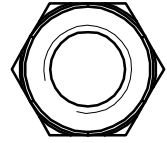
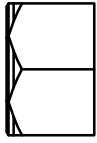

Part #41

NYLON LOCK NUT M10

QTY. 21

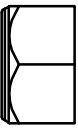

Part #42

NYLON LOCK NUT M8

QTY. 16

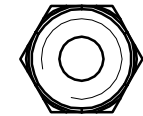
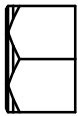

Part #43

NYLON LOCK NUT M6

QTY. 2



Part #44

HEX NUT 1/2"

QTY. 1

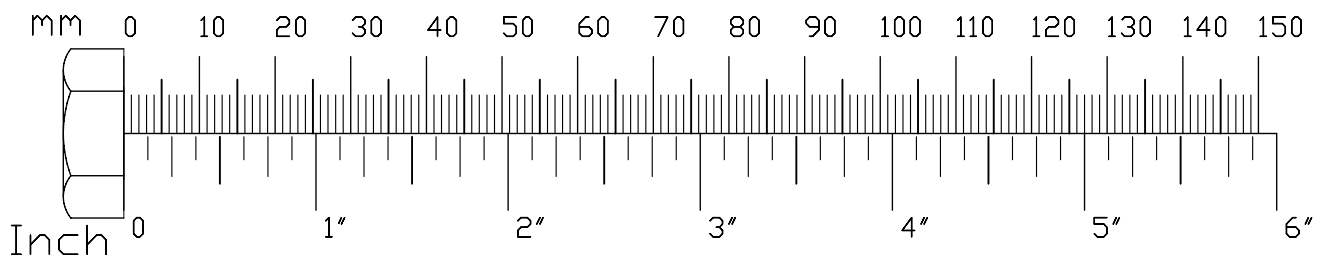
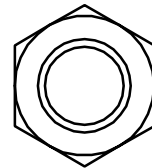
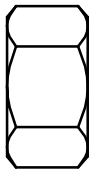

# S2PEC Hardware Illustration

Part #44

HEX NUT 1/2"-13

QTY. 1

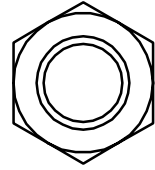
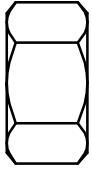

Part #45

RIVET NUT M10X18.5mm

QTY. 2

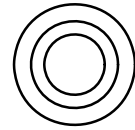
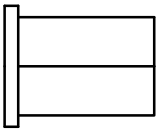

Part #50

FLAT WASHER  $\phi 13 \times \phi 24 \times 2.5 \text{mm}$

QTY. 10

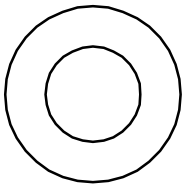

Part #51

FLAT WASHER  $\phi 11 \times \phi 20 \times 2 \text{mm}$

QTY. 46

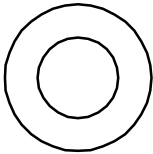

Part #52

FLAT WASHER  $\phi 9 \times \phi 16 \times 1.6 \text{mm}$

QTY. 20

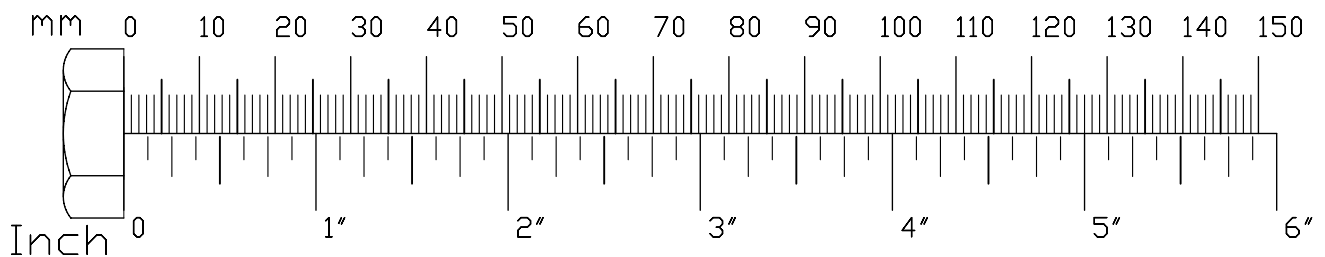
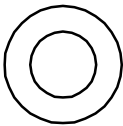

# S2PEC Hardware Illustration

Part #53

FLAT WASHER  $\phi 6.6 \times \phi 12 \times 1.6 \text{mm}$

QTY. 3



Part #54

FLAT WASHER  $\phi 11 \times \phi 30 \times 2 \text{mm}$

QTY. 3

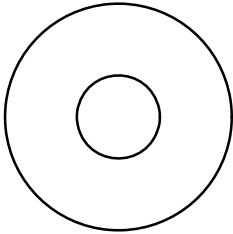

Part #55

SPRING WASHER 1/2"

QTY. 2

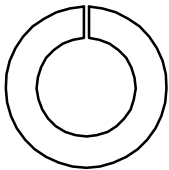

Part #56

SPRING WASHER  $\phi 10 \text{mm}$

QTY. 4

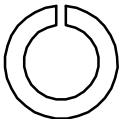

Part #57

SPRING WASHER 3/8"

QTY. 1

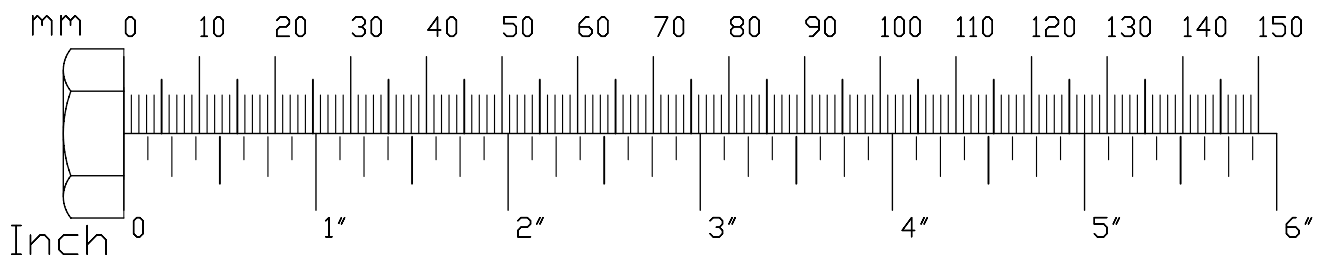
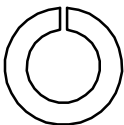

# S2PEC Parts List/illustration

**PART A-FRAME A, 1PCS.**

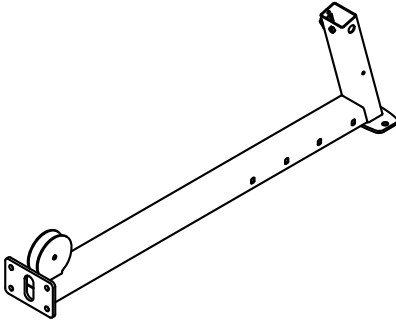

**PART E-UPPER ARM, 2PCS.**

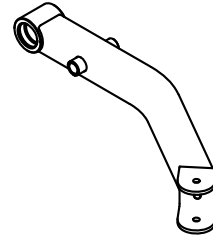

**PART B-FOOT PLATE, 2PCS.**

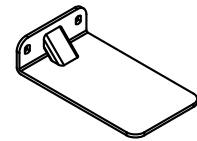

**PART F-LEFT ARM, 1PCS.**

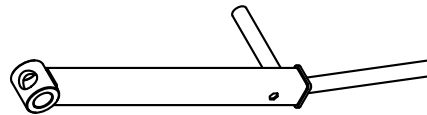

**PART C-FRAME C, 1PCS.**

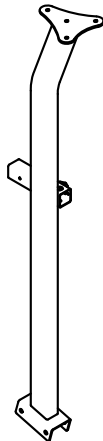

**PART G-RIGHT ARM, 1PCS.**

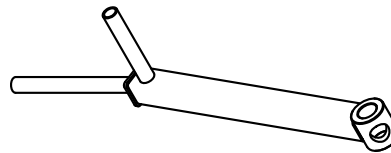

**PART D-FRAME D, 1PCS.**

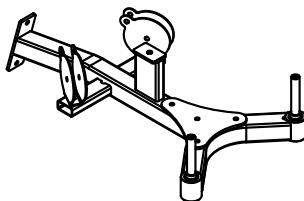

**PART H-TOP FRAME, 1PCS.**

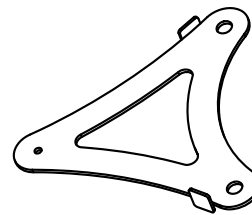

**PART J-RIGHT CAM, 1PCS.**

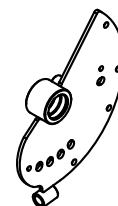

# S2PEC Parts List/illustration

**PART K-LEFT CAM, 1PCS.**

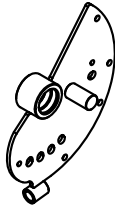

**PART WN-SHORT METAL SHROUD, 1PCS.**



**PART L-SEAT FRAME, 1PCS.**

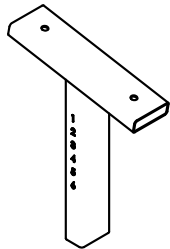

**PART WP-LONG METAL SHROUD, 1PCS.**



**PART M-BACK SEAT FRAME, 1PCS.**

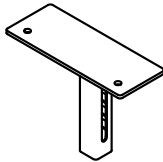

**PART WQ-CHROME GUIDE ROD, 2PCS.  
Φ19X1529mm**



**PART WA-WEIGHT STACK FRAM, 1PCS. PART WR-BACK SHROUD, 1PCS.**

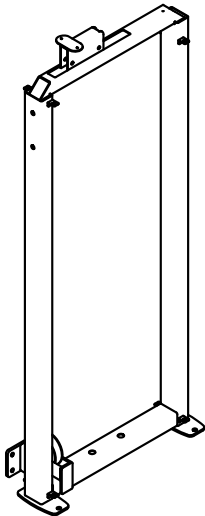



## S2PEC Parts List/illustration

**PART WS-FRONT SHROUD, 1PCS.**

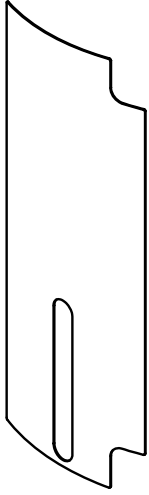

**PART WG-TOP SHROUD, 1PCS.**

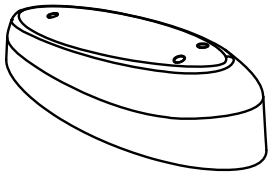

**PART WT-BRACKET, 1PCS.**

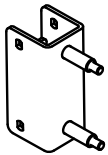

# S2PEC Parts List/illustration

**PART #60-PULLEY BRACKET, 1PCS.**

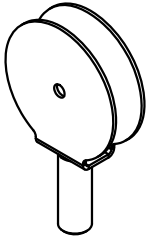

**PART #66-PLASTIC END CAP, 2PCS.  
25X50mm**

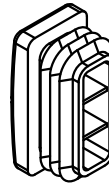

**PART #61-CABLE, 1PCS.  
3730mm**

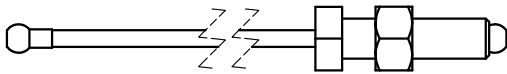

**PART #67-PLASTIC END CAP, 2PCS.  
25X76mm**

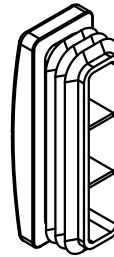

**PART #62-CABLE, 1PCS.  
2810mm**

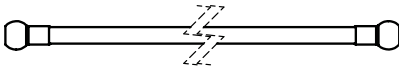

**PART #69-ADJUSTMENT LEVER, 2PCS.**

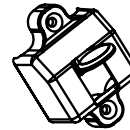

**PART #63-HANDLE SLEEVE, 2PCS.  
120mm**

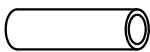

**PART #70-4.5" PULLEY, 7PCS.**



**PART #64-HANDLE SLEEVE, 2PCS.  
200mm**

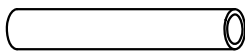

**PART #72-SEAT PAD, 1PCS.**

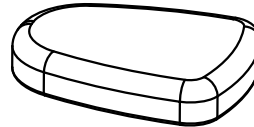

**PART #65-BUSHING, 4PCS.**



**PART #73-QUICK CABLE LOCK, 2PCS.**



# S2PEC Parts List/illustration

**PART #74-BUMPER, 2PCS.**

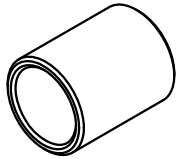

**PART #79-TOP PLATE, 1PCS.**

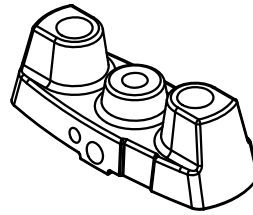

**PART #75-POP PIN, 2PCS.**

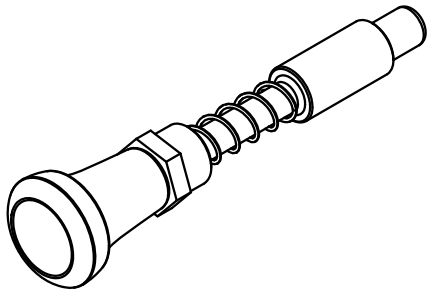

**PART #80-SELECTOR ROD, 1PCS.**

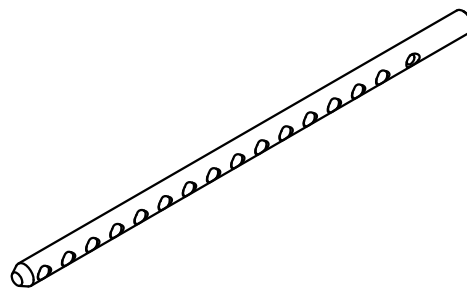

**PART #76-FOOT PAD, 3PCS.**

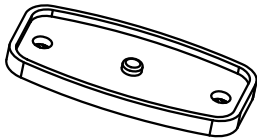

**PART #81-SELECTOR PIN, 1PCS.**

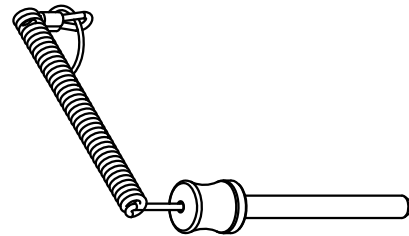

**PART #77-SPACER, 2PCS.**

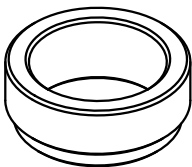

**PART #82-HANDLE END CAP, 4PCS.**



**PART #78-RUBBER DONUT, 2PCS.**

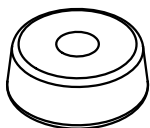

**PART #83-HANDLE RING, 4PCS.**



# S2PEC Parts List/illustration

**PART #84-SHAFT COLLAR, 2PCS.**

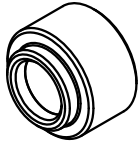

**PART #89-SPACER, 2PCS.**



**PART #84-PLASTIC PAD, 2PCS.**

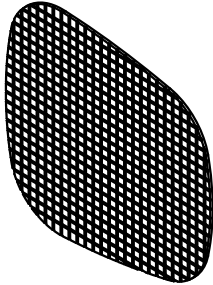

**PART #90-PLASTIC BUSHING, 4PCS.**



**PART #88-SHAFT PIN, 2PCS.**  
Φ25.4X69mm

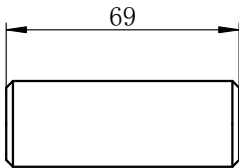

**PART #84-RUBBER BUMPER, 2PCS.**

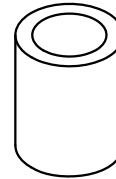

**PART #87-BUSHING, 4PCS.**

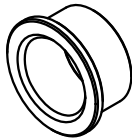

**PART #92-ADJUSTMENT PLATE, 2PCS.**



**PART #88-BEARING, 8PCS.**

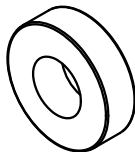

**PART #93-NYLON CAP, 2PCS.**

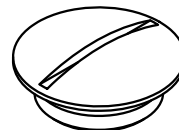

# S2PEC Parts List/illustration

**PART #94-RUBBER CAP, 4PCS.**



**PART #99-SNAP RING, 8PCS.**

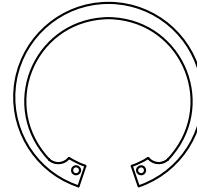

**PART #95-CAM TRACK, 4PCS.**



**PART #108-SELECTOR ROD TOP BOLT, 1PCS.**

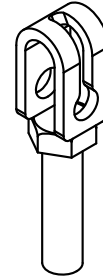

**PART #96-RUBBER CUSHION, 4PCS.**

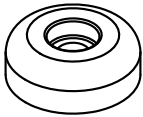

**PART #109-CYLINDER CABLE LOCK, 1PCS.**

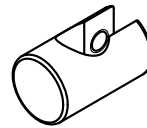

**PART #97-BACK PAD, 1PCS.**

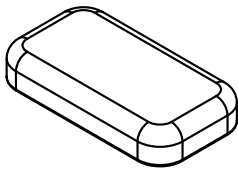

**PART #98-PLASTIC END CAP, 1PCS.  
50X50mm**

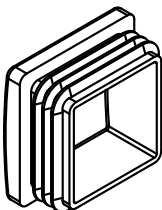

# Notes

**STEP****1**

**Be careful to assemble all components in the sequence they are presented.**

**NOTE:**

Finger tighten all hardware in this step. **DO NOT** wrench tighten unless instructed. Some components may be pre-assembled. Nylon lock nuts will not fully screw onto bolts, they must be wrench tighten to fully go on.

- 1A.** Attach Frame A (**A**) to Weight Stack Frame (**WM**) using:  
4 - (#15) M12X35mm Hex Head Bolt  
8 - (#50) 13mmX24mm Flat Washer  
4 - (#40) M12 Nylon Lock Nut
- 1B.** Attach two Foot Plates (**B**) to Frame A (**A**) using:  
2 - (#1) M10X105mm Hex Head Bolt  
4 - (#51) 11mmX20mm Flat Washer  
2 - (#41) M10 Nylon Lock Nut
- 1C.** Attach Frame C (**C**) and Frame A (**A**) using:  
2 - (#1) M10X105mm Hex Head Bolt  
4 - (#51) 11mmX20mm Flat Washer  
2 - (#41) M10 Nylon Lock Nut
- 1D.** Attach Bracket (**WT**) to Weight Stack Frame (**WM**) using:  
2 - (#50) 13mmX24mm Flat Washer  
2 - (#40) M12 Nylon Lock Nut
- 1E.** Attach Frame D (**D**) to Bracket (**WT**) using:  
2 - (#5) M10X30mm Hex Head Bolt  
4 - (#51) 11mmX20mm Flat Washer  
2 - (#41) M10 Nylon Lock Nut
- 1F.** Attach Frame D (**D**) to Frame C (**C**) using:  
3 - (#2) M10X80mm Hex Head Bolt  
6 - (#51) 11mmX20mm Flat Washer  
3 - (#41) M10 Nylon Lock Nut

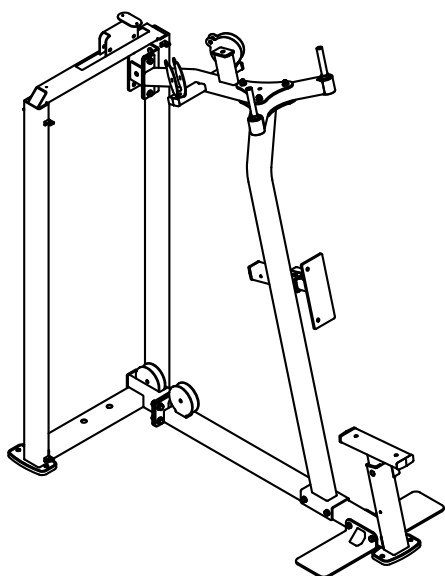

Above shows Step 1 assembled and completed.

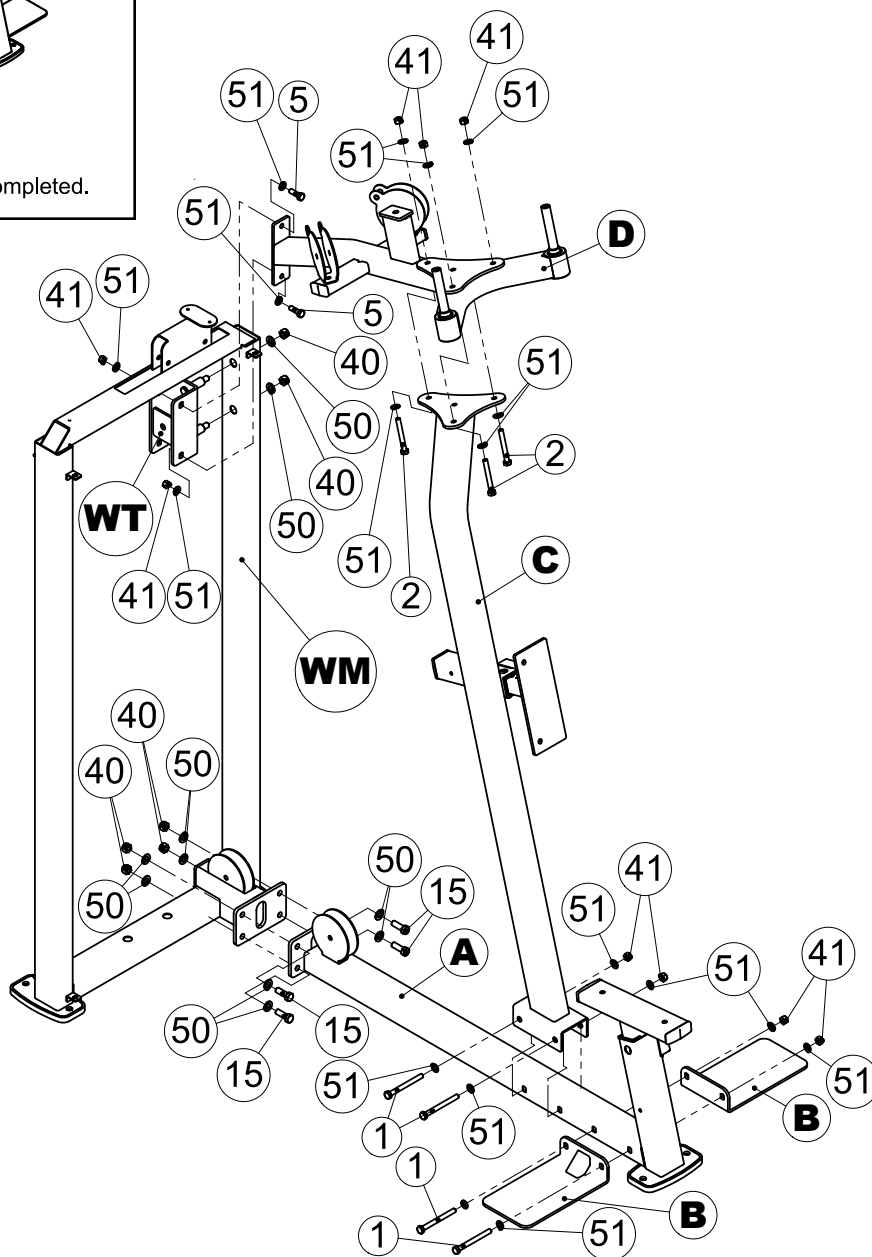



**STEP****2**

**Be careful to assemble all components in the sequence they are presented.**

**NOTE:**

Finger tighten all hardware first in this step. Wrench tighten ALL hardware at the end of **STEP 2D**. Some components may be pre-assembled. Nylon lock nuts will not fully screw onto bolts, they must be wrench tighten to fully go on.

- 2A.** Insert Upper Arms (**E**) onto Frame D (**D**).
- 2B.** Attach two Cams (**J & K**) to Frame D (**D**) using:
- 1 - (**H**) Top Frame
  - 2 - (**#89**) 25mm Spacer
  - 2 - (**#77**) 27.5mm Spacer
  - 3 - (**#6**) M6X25mm Hex Head Bolt
  - 3 - (**#54**) 11mmX30mm Flat Washer
- 2C.** Attach Left Arm (**F**) and Rubber Cushion (**#96**) to Frame E (**E**) using:
- 1 - (**#7**) M10X115mm Hex Head Bolt
  - 2 - (**#51**) 11mmX30mm Flat Washer
  - 1 - (**#41**) M10 Nylon Lock Nut
- 2D.** Attach Right Arm (**G**) and Rubber Cushion (**#96**) to Frame E (**E**) using:
- 1 - (**#7**) M10X115mm Hex Head Bolt
  - 2 - (**#51**) 11mmX30mm Flat Washer
  - 1 - (**#41**) M10 Nylon Lock Nut

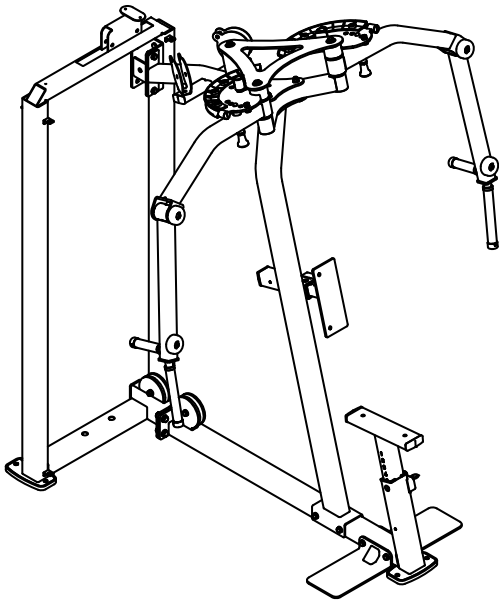

Above shows Step 2 assembled and completed.

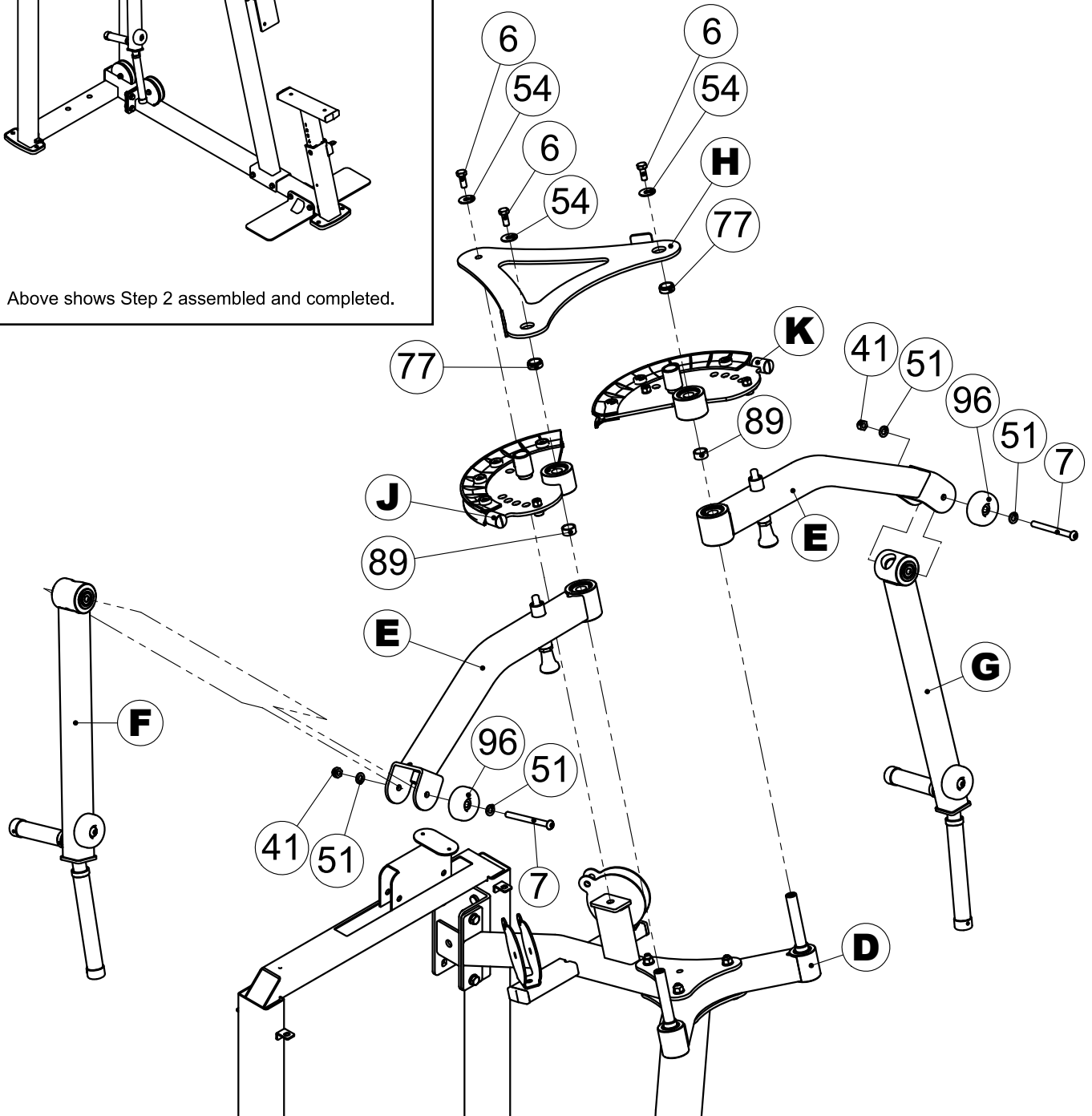

**STEP****3**

**Be careful to assemble all components in the sequence they are presented.**

**NOTE:**

Finger tighten all hardware first in this step. Wrench tighten ALL hardware at the end of **STEP 3D**. Some components may be pre-assembled. Nylon lock nuts will not fully screw onto bolts, they must be wrench tighten to fully go on.

**3A.** Install Chrome Guide Rods (**WQ**) into the holes in the Weight Stack Frame (**WM**).

**Note:** Install the rod ends with side holes into the bottom section of the Weight Stack Frame

**3B.** Install Rubber Donuts (**#78**) and slide to the bottom of the Guide Rods

**3C.** Tilt Guide Rods (**WQ**) away from the Weight Stack Frame (**WM**) and install 15pcs of weight plates (**#112**). Be careful to hold guide rods steadily when installing weight plates.

**Note:** Please make sure the grooves of the weight plates are faced down during installation.

**3D.** Install Top Plate & Selector Rod Assembly (**#8**) onto the Guide Rods .

**3E.** Install the Selector Rod Top Bolt (**#108**), the 1/2" Lock Nut (**#44**) and the 1/2" Spring Washer (**#55**) onto the Top Plate (**#60**).

**3F.** Install Shaft Collars (**#84**) onto the Guide Rods so they are directly below the guide rod holes in the upper section of the Weight Stack Frame.

**3G.** Slide Shaft Collars (**#84**) upward so they lock the guide rods into position by tightening the Set Screws (**#12**)

**3H.** Install Weight Stack Pin (**#81**) using the key ring end through the Selector Rod Top Bolt (**#108**).

**STEP**  
**3**

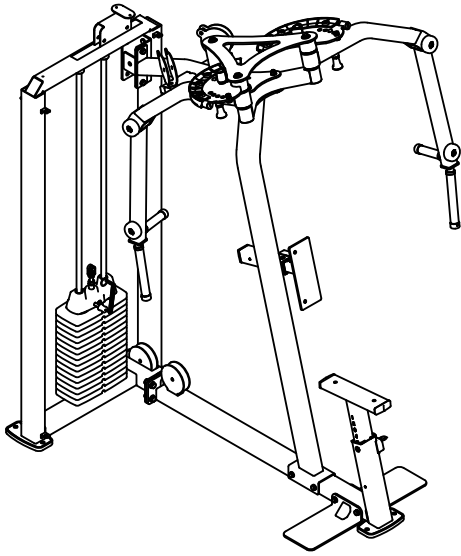

Above shows Step 3 assembled and completed.

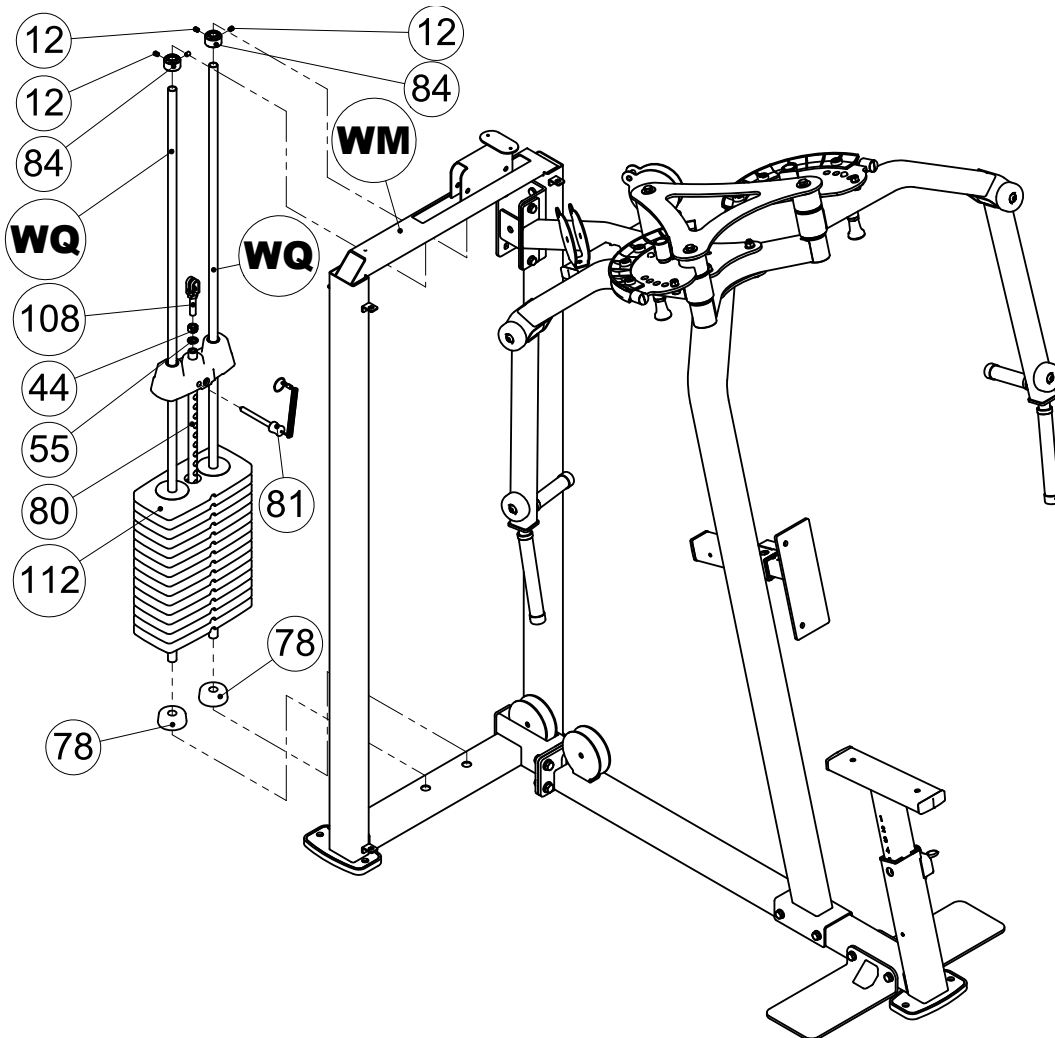

**STEP****4**

**Be careful to assemble all components in the sequence they are presented.**

**NOTE:**

Finger tighten all hardware first in this step. Wrench tighten ALL hardware at the end of **STEP 4G**. Some components may be pre-assembled. Nylon lock nuts will not fully screw onto bolts, they must be wrench tighten to fully go on.

- 4A.** Route Cable (**#62**) while installing three Pulleys (**#70**) as shown in Step 4 Drawing using:
- 5 - (**#3**) M10X50mm Hex Head Bolt
  - 10 - (**#51**) 11mmX20mm Flat Washer
  - 5 - (**#41**) M10 Nylon Lock Nut
  - 1 - (**#60**) Pulley Bracket
- 4B.** Put the ends of the Cable (**#62**) through the holes of the Cam (**J & K**). Install the Quick Cable Locks (**#74**) at the ends of the cable. Put the Nylon Caps (**#93**) onto the hole of Cam (**M**)
- 4D.** Connect Cable (**#61**) to Pulley Bracket (**#60**) using:
- 1 - (**#55**) 1/2" Spring Washer
  - 1 - (**#41**) M10 Nylon Lock Nut
- 4E.** Route Cable (**#61**) while installing four Pulleys (**#70**) into frames as shown in Step 4 Drawing using:
- 4 - (**#3**) M10X50mm Hex Head Bolt
  - 8 - (**#51**) 11mmX20mm Flat Washer
  - 4 - (**#41**) M10 Nylon Lock Nut
- 4F.** Connect Cable (**#61**) by first assembling the ball end into the Selector Rod Top Bolt (**#108**) and attaching the Cable Cylinder Lock (**#109**) over the ball end of the cable. Secure it by tighten in the Set Screw (**#14**).
- 4G.** Install the M10X35mm Hex Head Bolt (**#4**) through the slot hole of the Selector Rod Top Bolt (**#108**) by fastening the M10 Nylon Lock Nut (**#41**).

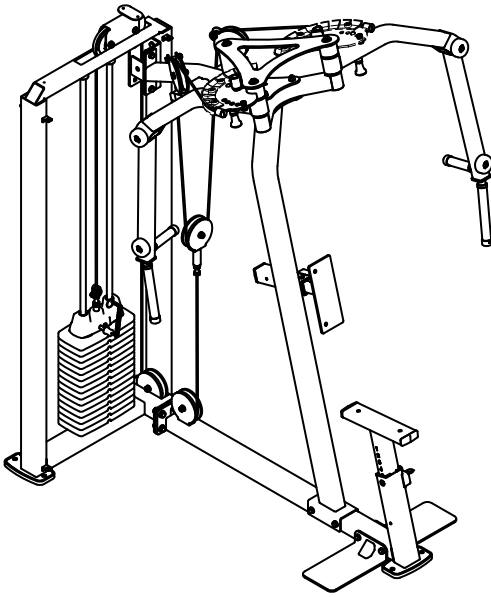

Above shows Step 4 assembled and completed.

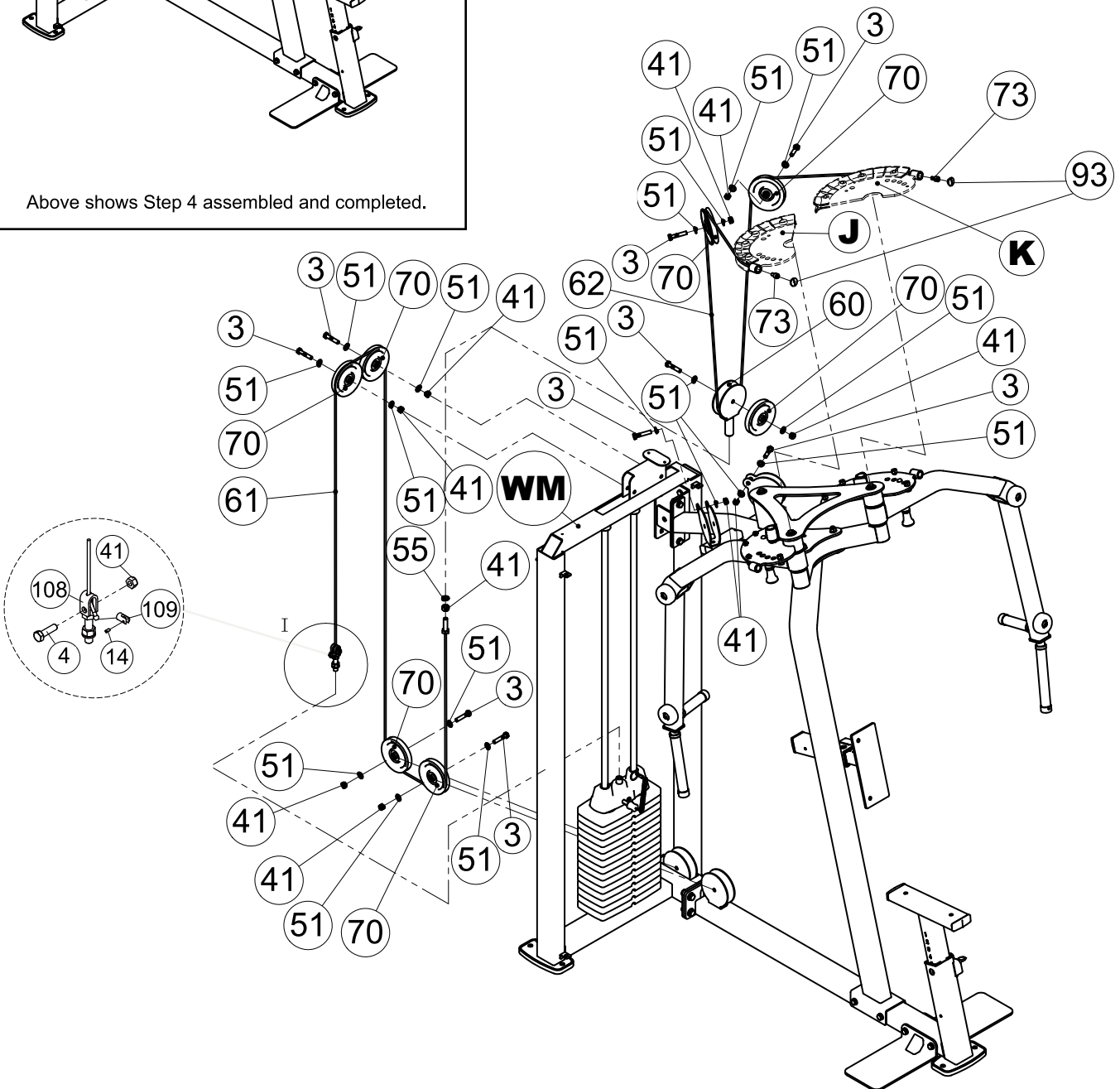

**STEP****5**

**Be careful to assemble all components in the sequence they are presented.**

**NOTE:**

**Wrench tighten ALL hardware at the end of Each Step. Some components may be pre-assembled. Nylon lock nuts will not fully screw onto bolts, they must be wrench tighten to fully go on.**

- 5A.** Attach Short Metal Shrouds (**WN**) and Long Metal Shrouds (**WP**) to Weight Stack Frame (**WM**) using:
- 4 - (#9) M8X25mm Button Head Cap Screw**
  - 8 - (#52) 9mmX16mm Flat Washer**
  - 4 - (#42) M8 Nylon Lock Nut**
- 5B.** Bend the Plastic Shrouds (**WS & WR**) and insert them to the side slots of the Metal Shrouds (**WN & WP**).
- 5C.** Attach Top Shroud (**WG**) to Weight Stack Frame (**WA**) using:
- 3 - (#13) M6X16mm Phillips Head Screw**
  - 3 - (#53) 6.6mmX12mm Flat Washer**

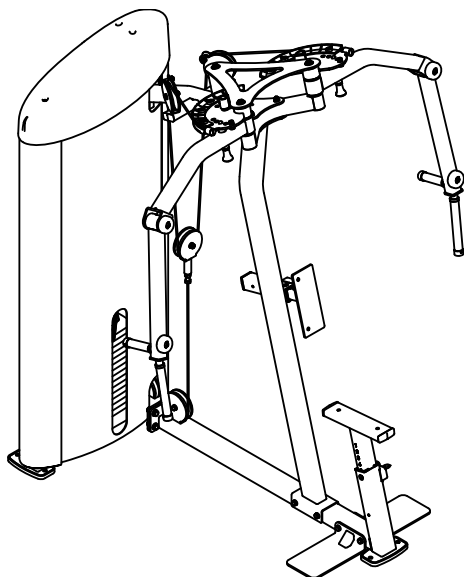

Above shows Step 5 assembled and completed.

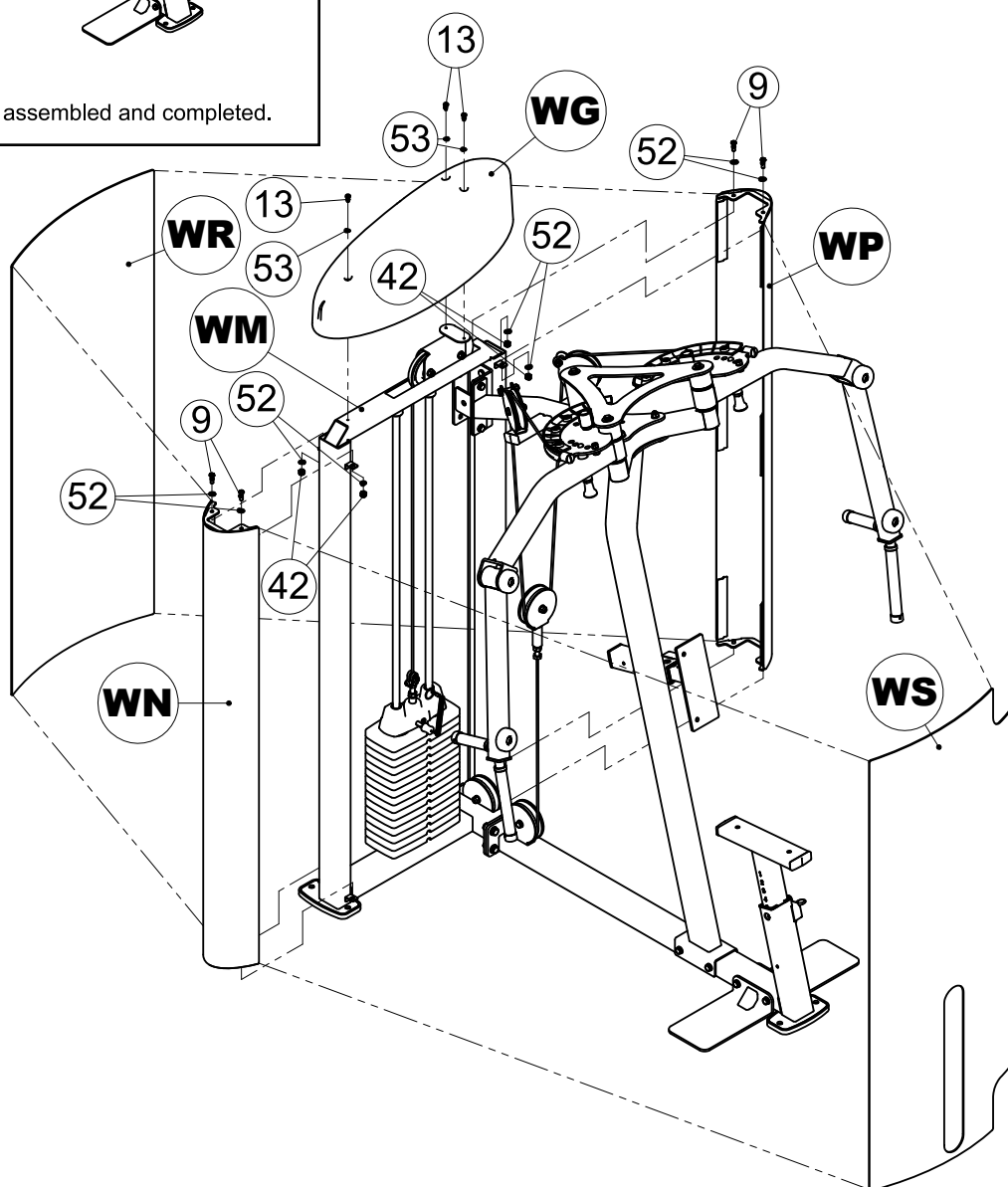



**STEP****6**

**Be careful to assemble all components in the sequence they are presented.**

**NOTE:**

**Wrench tighten ALL hardware at the end of Each Step. Some components may be pre-assembled. Nylon lock nuts will not fully screw onto bolts, they must be wrench tighten to fully go on.**

- 6A.** Attach Back Pad (#79) to Back Seat Frame (M) using:
- 2 - (#5) M10x30mm Hex Head Bolt**
  - 2 - (#56) 10mm Spring Washer**
  - 2 - (#51) 11mmX20mm Flat Washer**
- 6B.** Attach Seat Pad (#72) to Seat Frame (L) using:
- 2 - (#3) M10x50mm Hex Head Bolt**
  - 2 - (#56) 10mm Spring Washer**
  - 2 - (#51) 11mmX20mm Flat Washer**

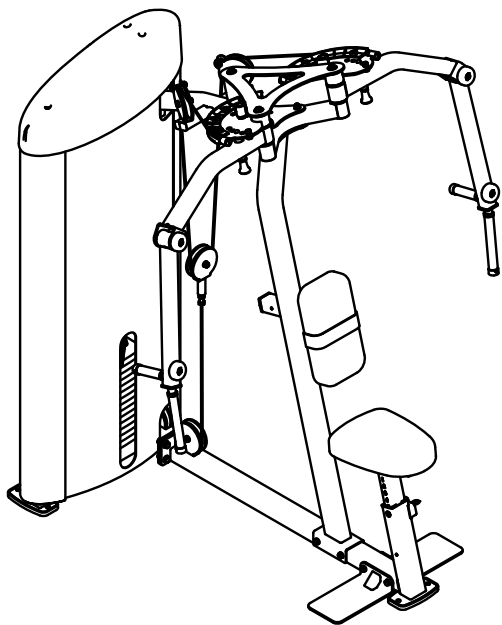

Above shows Step 6 assembled and completed.

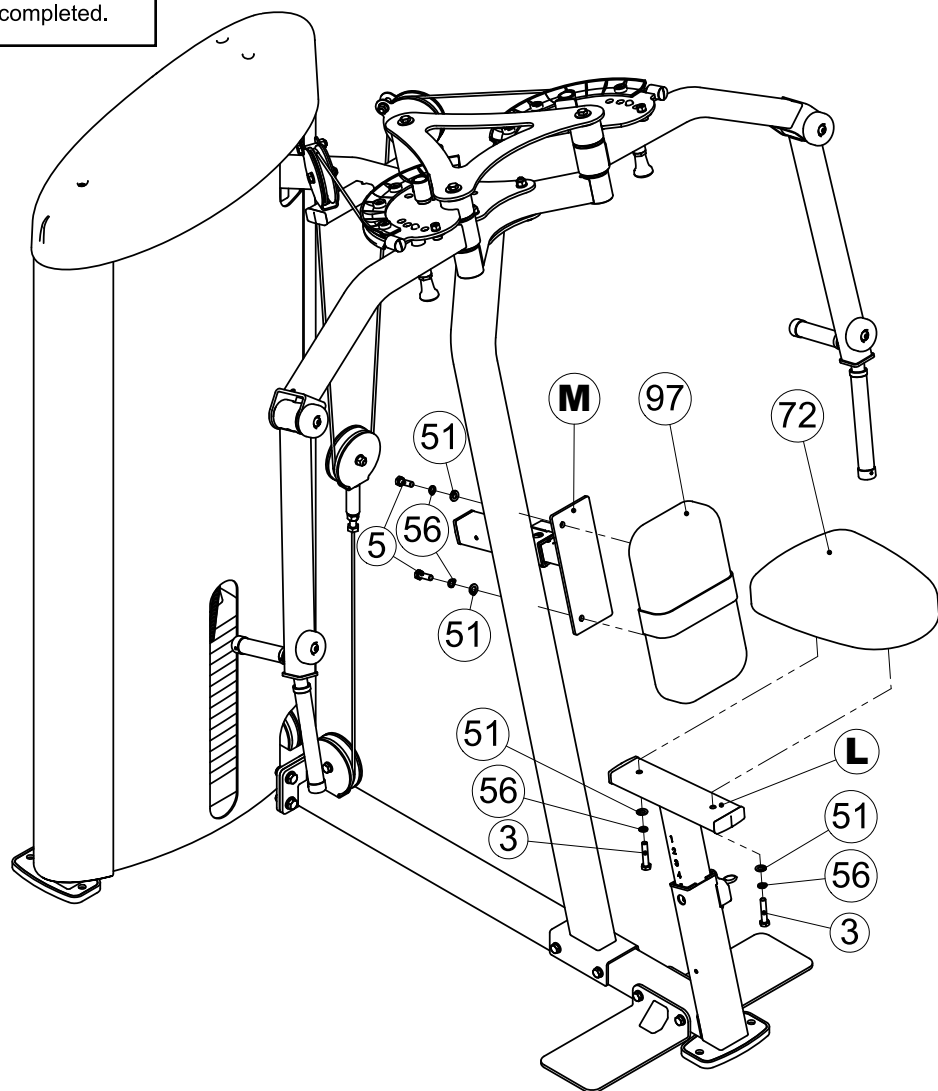

## PCL Badge Location



# S2PEC Exploded View

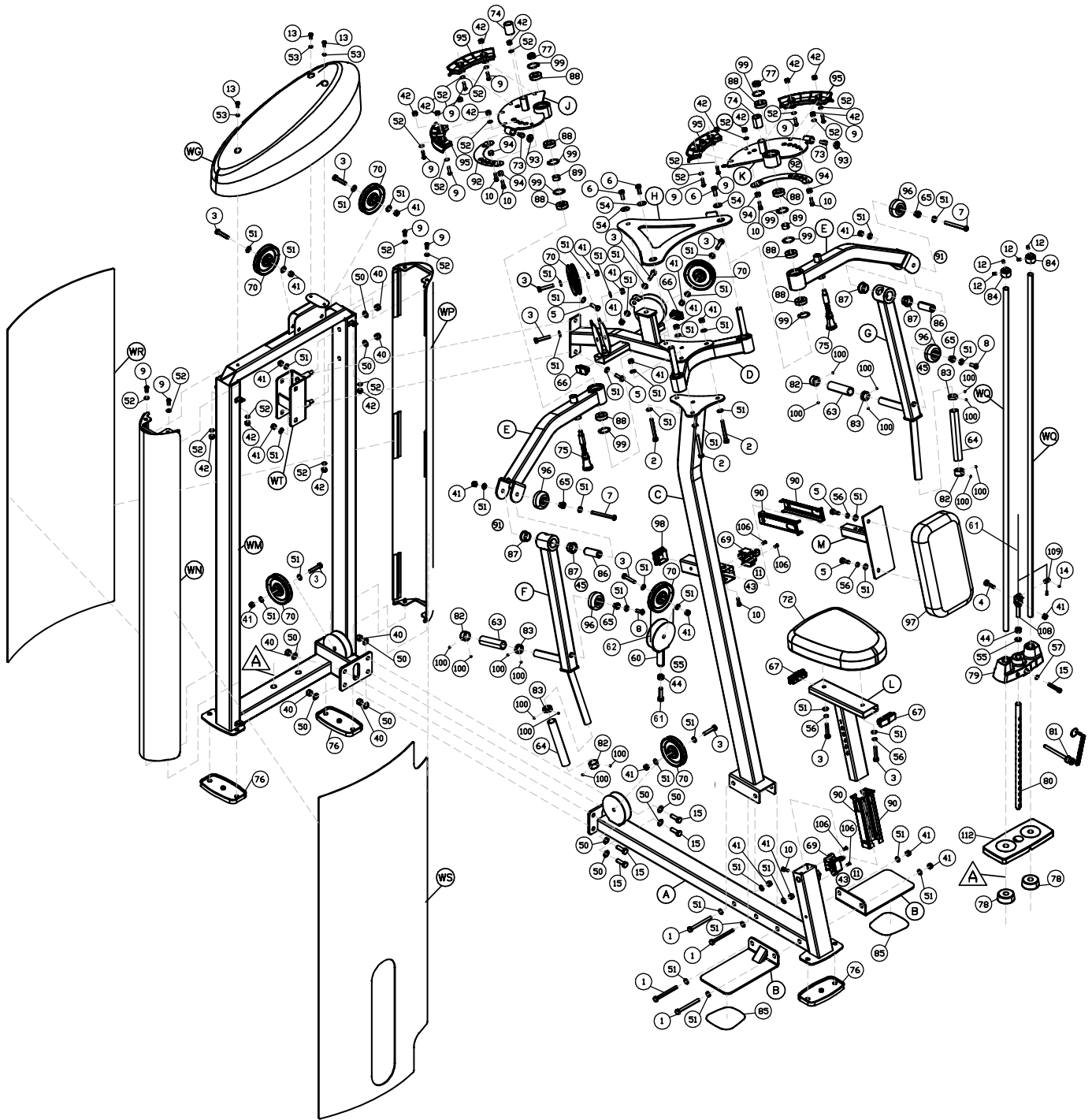

*Body-Solid*<sup>®</sup>  
Built for Life

# S2PEC

PLEASE WRITE YOUR SERIAL NUMBER IN THE BOXES BELOW

S/N # **008182**----

1900 S. Des Plaines Ave.  
Forest Park, IL 60130  
Phone:(708)427-3555  
Fax:(708)427-3556  
Hours: M-F 8:30 - 5:00 CST

*www.bodysolid.com*