

Инструкция

Эллиптический тренажер AnyFit AI-3

Полезные ссылки:

[Эллиптический тренажер AnyFit AI-3 - смотреть на сайте](#)

AnyFit

ANYFIT HEALTH TECH GMBH (international)
Hanauer Landstr. 287-289,60314 Frankfurt am Main, DE
P: +49(0)69 90439168
F: +49(0)69 90439169
E: account-office@anyfit.de
W: www.anyfit.de



USER'S MANUAL

AI 3 ELLIPTICAL

Read this manual before operating!

AI 3 ELLIPTICAL

Before using this product, read all instructions in the document provided with our exercise equipment, including all assembly guides, user guides, and owner's manuals, before installation of this device.



Read all instructions in the documentation provided with your exercise equipment. This product is intended for commercial use

IMPORTANT SAFETY INSTRUCTIONS

WARNING

Save these instructions for future reference.

WARNING

Make sure all users see a physician for a complete physical examination before they begin any fitness program, particularly if they have high blood pressure, high cholesterol or heart disease; have a family history of any of the preceding condition; are over the age of 35; smoke; are obese; have not exercised regularly in the past year; or are taking any medication.

Safety Precautions

Always follow basic safety precautions when using this equipment to reduce the chance of injury, fire, or damage. Other sections in this manual provide more details of safety features. Be sure to read these sections and observe all safety notices. These precautions include the following:

- Read all instruction in this guide before installing and using the equipment and follow any labels on the equipment.
- Make sure all users see a physician for a complete physical examination before they begin any fitness program.
- Do not allow children, and people unfamiliar with the operation of this equipment, on or near it. Do not leave children unsupervised around the equipment.
- Make sure all users wear proper exercise clothing and shoes for their workouts and avoid loose or dangling clothing. Users should not wear shoes with heels or leather soles, and they should check the soles of their shoes to remove any dirt and embedded stones. They should also tie long hair back.
- Never leave the equipment unattended when it is plugged in. Unplug the equipment from its power source when it is not in use, before cleaning it, and before providing authorized service.
- Use the power adapter provided with the equipment. Plug the power adapter into an appropriate, grounded power outlet as marked on the equipment.
- Care should be taken when mounting or dismounting the equipment.
- Read, understand, and test the emergency stop procedures before use.
- Keep the power cord or optional power adapter and plug away from heated surfaces.
- Route power cables so that they are not walked on, pinched, or damaged by items placed upon or against them, including the equipment itself.
- Ensure the equipment has adequate ventilation. Do not place anything on top of or over the equipment. Do not use on a cushioned surface that could block the ventilation opening.
- Assemble and operate the equipment on a solid, level surface.
- Place the unit on a level surface, there should be 1 meter of clearance from each side. Treadmill, there should be 2 meters of clearance from each side.

Other Important Safety instructions

- Keep equipment away from water and moisture. Avoid dropping anything on or spilling anything inside the equipment to prevent electric shock or damage to the electronics.
- Do not operate electrically powered equipment in damp or wet locations.
- Never operate this equipment if it has a damaged cord or plug, If it is not working properly, or if it has been dropped, damaged, or exposed to water, call for service immediately if any of these conditions exist.
- Maintain the equipment to keep it in good working condition, as described in the maintenance section of the owner' s manual. Inspect the equipment for incorrect, worn, or loose components, and then correct, replace or tighten prior to use.
- Equipment Weight Restrictions: Do not use the unit if you weigh more than 180kg.
- Use the Equipment only for its intended purpose as described in this manual. Do not use accessory attachments that are not recommended by ANYFIT. Such attachments many cause injuries.
- Do not operate the equipment where aerosol(spray) products are being used or where oxygen is being administered.
- Do not use outdoors.
- Do not attempt to service the equipment yourself, except to follow the maintenance instructions in the owner' s manual.
- Never drop or insert objects into any opening. Keep hands away from moving parts.
- Do not set anything on the stationary handrails, handlebars, control console, or covers. Place liquids, magazines, and books in the appropriate receptacles.
- Do not lean on or pull on the console at any time.



Caution: Do not remove the cover, or you may risk injury due to electric shock. Read the assembly and maintenance guide before operating. There are no user-serviceable parts inside. Contact customer support if the equipment need servicing.

TABLE OF CONTENTS

Important Safety Instructions-----	2
Assembly Instructions-----	5
Assembly Steps-----	6
Console description -----	10
Operating instructions-----	12
Exercise instructions-----	13
Maintenance-----	14
Warranty -----	15
Customer Service-----	16
Specification-----	16

Assembly Instructions



DANGER!

Always unplug the unit from the electrical outlet immediately after using, before cleaning, performing maintenance and putting on or taking off parts.

- Read all instructions in this guide before installing.
- Assemble and operate your equipment on a hard, level surface in the area intended for use.
- Open the box and assemble the components in the sequence presented in this guide.
- Attach all fasteners and partially tighten them. Do not fully tighten fasteners until instructed to do so.
- Do not attempt to move the equipment by yourself. Have at least one other person help you, and use safe lifting techniques. Do not grasp any plastic parts of the unit while lifting or moving the unit. The plastic parts are non-structural covers and are not capable of supporting the weight of the unit.

Hardware Kit

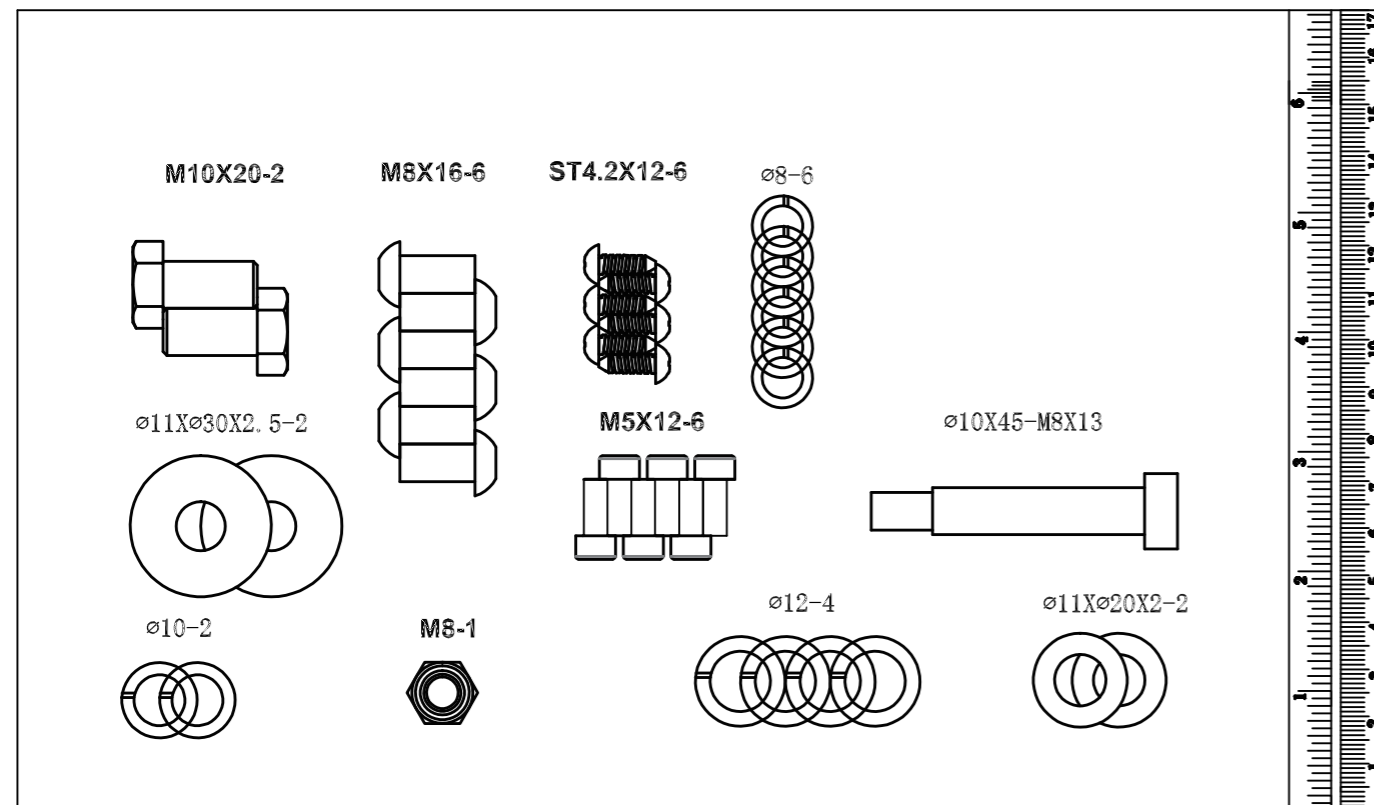

Assembly Steps

Step 1

- ① Remove the packing tape and open the carton, as shown below

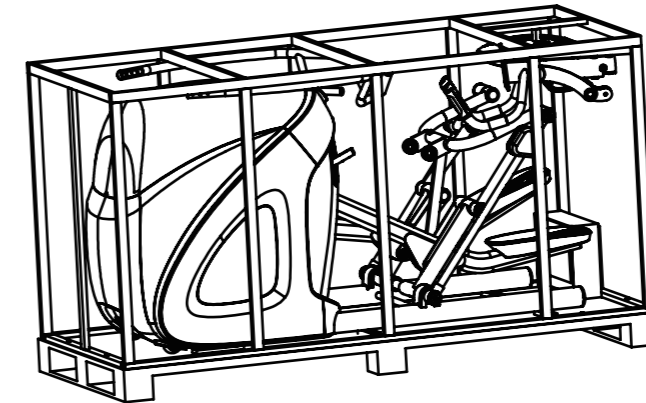

Step 2

- ① Take down the big handrail, console, console stand and parts box. Take down the wood screw which is used to connect the frame and pallet. (keep the bolt which is used to secure the console, and will be used to assemble the machine)

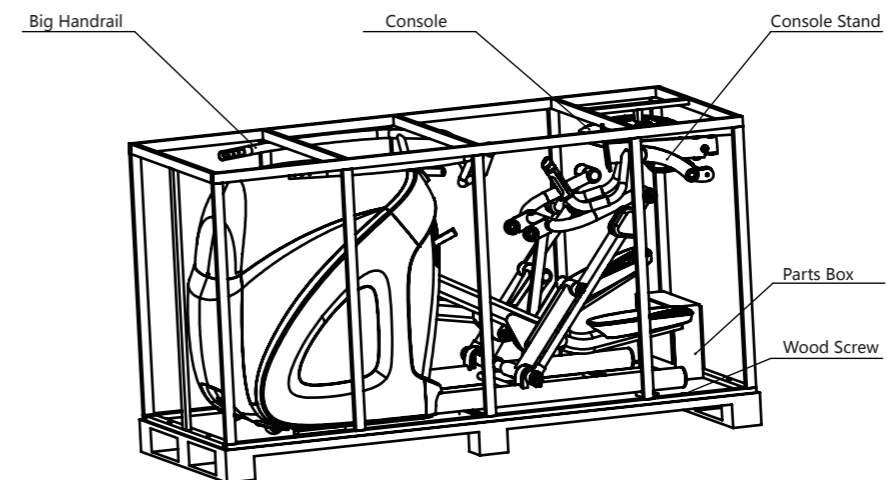

Assembly Steps

Step 3

- ① Take down the frame and upper shell.

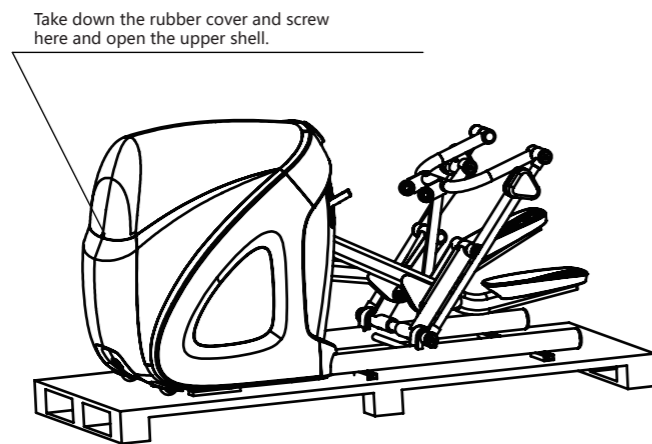

Step 4

- ① Take down the fixture of incline adjusting motor, and assemble the console stand and console.

Fix the column use M12*20 hexagon bolt(4pcs) and Φ 12 spring washer(4pcs)

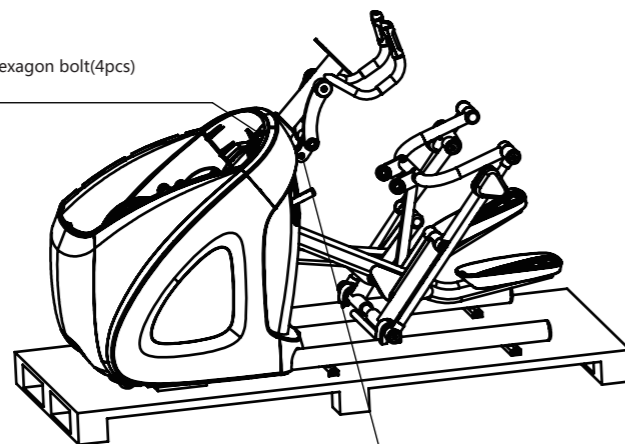

Fix the parts use Φ 10x45-M8x13 shaft shoulder bolt(1pc), Φ 10 flat washer(2pc)

Assembly Steps

Step 5

- ① Assemble U frame and foundation.

Fix U frame shaft with M10*40 hexagon bolt and Φ 10.5x Φ 30x2.5 flat washer.

Take down the bolt here and push the U frame stand to connect with incline adjusting stand.

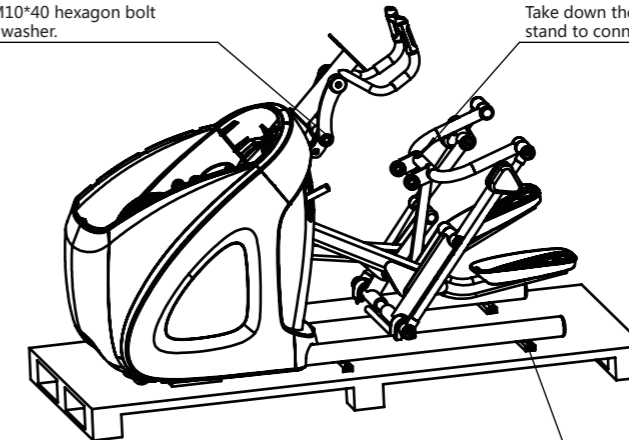

Take down the connecting tube and fix the foundation.

Step 6

- ① Push the machine to appointed place from the pallet.

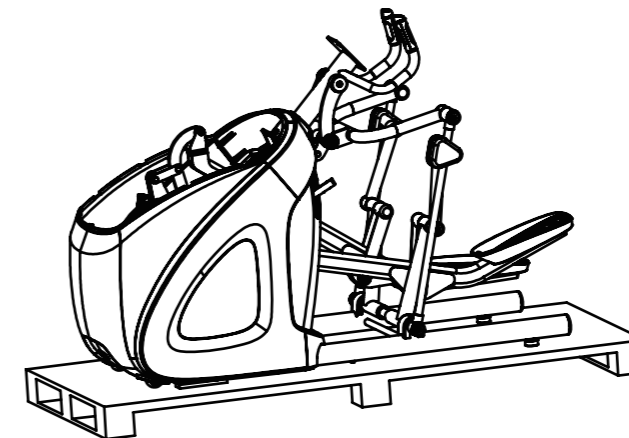

Assembly Steps

Step 7

① Assemble big handrail, console, and cables.

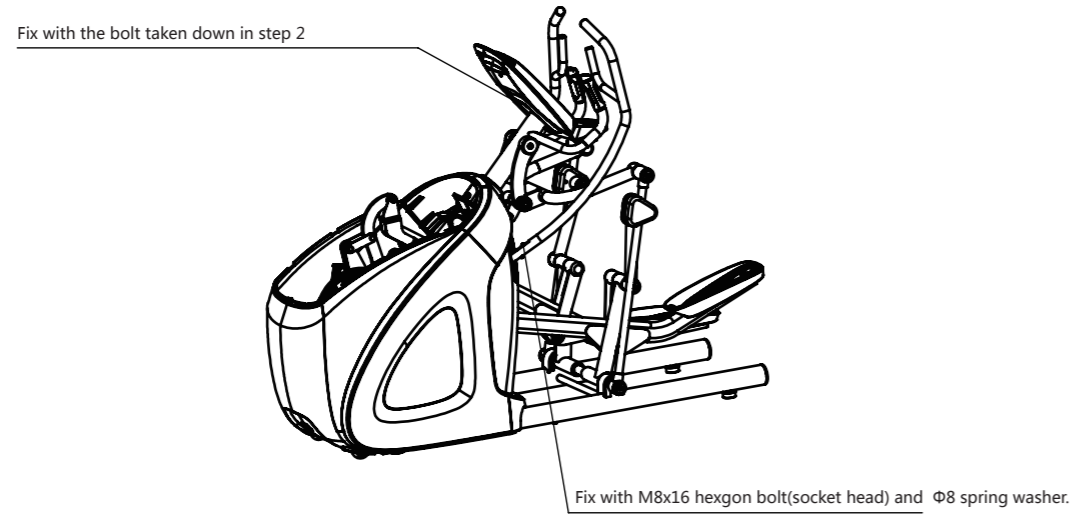

Step 8

① Fix plastic shell and adjust the machine.(fix big handrail plastic shell with M5*12 socket head hexagon bolt,fix the incline adjusting shell and incline adjusting stand shell with ST4.2x12 self-tapping screw)

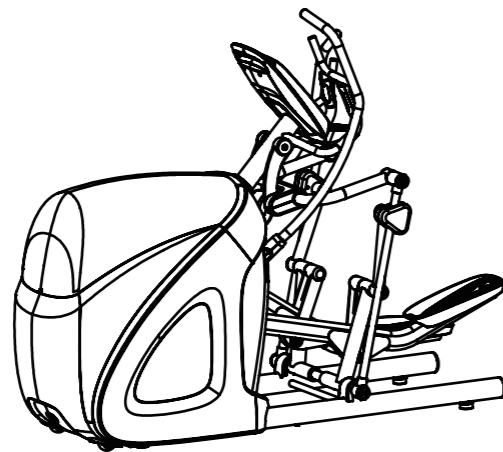

Console description

Display

LED display console, show us following information:

Time(S): display from " 00:00-99:59" ; Default time for positive timing,Increment with each 1 second.

Distance(Km): display from" 0-99.9" ; Default distance is positive timing, increment with each 0.1Km

Calorie (Kcal): display from" 0-99.9" default Calorie is positive timing, Increment with each 0.1 Kcal.

Speed (Km/h):Display from" 0-100km/h" Increment with each 0.1km/h









Intensity: display from "1-25" ;

Incline : display from "1-15" ;

Stride : display from "1-10" ;





Console description

Number	Name	Details
①	light language	Blue(3seconds): Power On Breathing blue: Standby Flashing Blue: Searching bluetooth/ Logging into the system Green: System login succeeded Flashing Red(2sec): System login failed Yellow(60seconds): Pause state Blue(1Second):Cool Down Red(1second):Stop Red(2Second): Exit system
②	Distance Heart Rate Frequency	Use  button to change
③	Push arm Low speed Pull arm High speed Leg Training Reverse	Display action guidance in programs
④	Speed Average Speed PRM	Use  button to change
⑤	Program	6 programs, One button start
⑥	LED display	Information about the training
⑦	Numeric Keypad	Input the Age, weight and password etc. Press  to delete.After input the number, press OK to confirm.
⑧	View	After the end of the exercise, the system will automatically save the current exercise data, click on the view to display the current exercise result data
⑨	Fan	Adjust the speed of fan: low, high
⑩	Level	Press   adjust exercise intensity
⑪	Target Program	Set exercise target, include Time, distance, Koal
⑫	Self-editing Program	Set self-editing program
⑬	Incline	Press   adjust Incline
⑭	Stride	Press   adjust Stride
⑮	Start/Stop	When unit stopped, press this button to start. When unit running, press this button to stop.
⑯	USB	Charging for mobile electronic devices
⑰	NFC Identification	Identify user information (smart system version)





Operating instructions

Quick start









- Press  button, all data starts counting, The bottom line of display bright. display lights and intensity adjustment linkage; press buttons - + to adjust intensity, the data can be switched.
- Press  button, to clear all the data, display remind "ANYKEY TO CONTINUE OR PRESS OK TO QUIT" , press any key to continue use the unit, press  button to quit.

Preset program starting up



- Choose any program when display "START OR PRESS OK TO SET UP"
Press  button, to start preset program, default time 30 min, level linkage adjustment (Flexible adjustment stride and incline) .
Press  button, to set program:
1、 Age Setting(10-90): display remind" Enter your age" (input your age) default" 35" , press - + to choose or input your age directly, press  to next step
2, weight Setting(30-180): display remind" Enter your weight(input your weight) default" 65" , press -+ to choose or input your weight directly, press  to next step;
3, Time Setting(5-99): display remind "ENTER TIME" (input time) default "30min" press - + to choose or input time directly, press  to "PRESS START TO BEGIN."

Target program starting up

- Press  button, display remind" SET TIME OR ENTER THE NEXT TARGET" same time, Time Window Flashes. Default time 30min; setting interval 5:00-99.00; adjust with - + button, 1min each press or use numeric keypad to setting detail time, press , display remind " PRESS START TO BEGIN" , press  to start the unit.
- Press  button, display remind" SET DISTANCE OR ENTER THE NEXT TARGET" Same Time, Distance window flashes. Default setting1.0Km, setting interval 1-99; setting with - + button, 1km each press, or use numeric keypad to setting detail distance, After press , display remind" PRESS START TO BEGIN" , press  button to start.
- Press  button, display remind" SET CALORIES OR ENTER THE NEXT TARGET" same time, Calories window flashes, default setting 50Kcal; Setting interval 50-990; setting with - + button, 10Kcal each press, or use numeric keypad to setting detail calories, press  button, display remind "PRESS START TO BEGIN" , press  button to start.

Operating Instructions

Self-Editing program starting up

- Press **[M]** Button, display remind " USER PROGRAM" After the information finished, the first line of display is displayed. The first light flashes, setting with - +, each press 1vl, or use numeric keypad to setting details, press **[OK]** to next step, when finish last step, press **[OK]**, display remind "ENTER TIME" ,press **[OK]**,display remind " PRESS START TO BEGIN" , press **[Start]** to begin exercise.

Exercise instructions

Medical research results show that, Certain exercise can promote the recovery of our cardiopulmonary system and muscle tissue. At the same time, it is safe and effective to control the exercise intensity to 60%-85% of the maximum heart rate during fitness exercise. Because this interval can fully achieve the effect of different needs, And it does not cause damage caused by excessive exercise, etc.

Maximum heart rate and exercise heart rate interval

Please use the following formula to calculate the maximum heart rate and exercise interval(Taking 35 years old as an example):

Max heart rate=220-age(220-35=185/min)

Exercise heart rate upper limit=max heart rate*85%(185*85%=157times/min)

Exercise heart rate lower limit=max heart rate*60%(185*60%=111times/min)

Then the exercise heart rate interval is 111-157 times / minute

Maintenance

⚠ WARNING

To reduce the risk of electrical shock,always unplug the equipment from its power source before cleaning it or performing any maintenance tasks.

Cleaning console and screen

- Use mild soap and water to dampen a soft cloth and wipe all exposed surfaces. CAUTION: Do not use any acidic cleaners. Doing so will weaken the paint or powder coating. Never pour water or spray liquids on any part of the equipment.
- Avoid any corrosive chemicals on console and screen
- Water to dampen a soft cloth and then clean the screen. Make sure to spray the cleaning solution on the soft cloth, not console.
- Do not use a hard cloth to clean

Heart Rate Target Zones

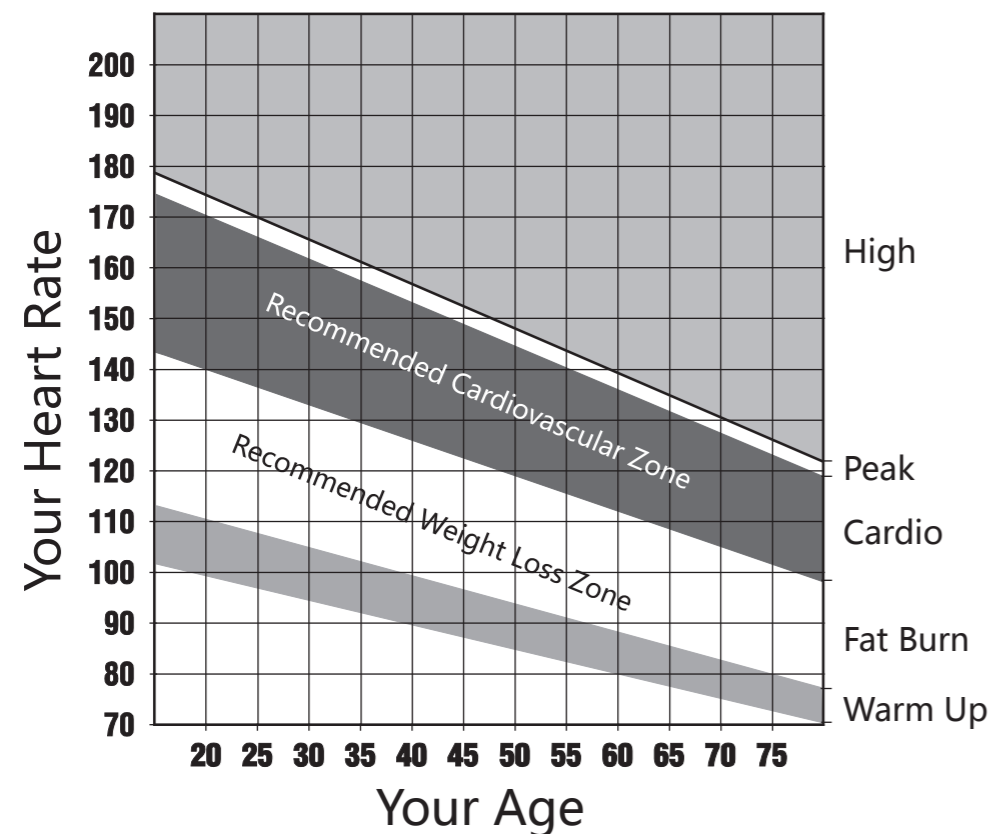

Warranty

AnyFit warrants the equipment to be free from defects in materials and manufacture for the warranty periods set forth below. The warranty periods commence on the invoice date of original purchase. This warranty applies only against defects discovered within the warranty periods and extends only to the original purchaser of the product. Parts repaired or replaced under the terms of this warranty will be warranted for the remainder of the original warranty period only. To make a claim under warranty, the buyer must notify AnyFit or his or her authorized AnyFit distributor within 30 days after the date of discovery of any nonconformity and make the affected product available for inspection by AnyFit or its service representative. AnyFit's obligations under this warranty are limited as set forth below.

Warranty Periods and Coverage

Structural Frame: 10 YEARS

Running belt, running deck, transmission belt: THREE YEARS

Motor: EIGHT YEARS

Motor controller: THREE YEARS

Generator/EMS/ECB brake: TWO YEARS

ICD screen: TWO YEARS

Key Pad: ONE YEAR

Mechanical and Electrical Parts (including PVS, transmitters): TWO YEARS

High Wear Console Items, including: Headphone Jacks, USB Connectors): 180 DAYS

Media Receiver Boxes: TWO YEARS

Batteries, Non-integrated Receivers: ONE YEAR

Conditions and Restrictions.

- 1.This warranty does not apply to damage caused by modification, accident, misuse, improper maintenance without AnyFit's authorization, including but no limits: handlebar,upholstery pads, labels and other spare parts.
- 2.This warranty does not apply to AnyFit products'serial tag that has been altered or defaced.
- 3.If return the equipment to AnyFit, the user should package properly to avoid any damage during transportation.

Customer Service

The Customer Service Hotline of AnyFit is a bridge linking users and AnyFit, which is a direct, fast and efficient communication way between customers and AnyFit.

Through the customer service hotline service, you can learn all the related information regarding for AnyFit.

ANYFIT HEALTH TECH GMBH (international)
Hanauer Landstr. 287-289,60314 Frankfurt am Main, DE
P: +49(0)69 90439168
F: +49(0)69 90439169
E: account-office@anyfit.de
W: www.anyfit.de

Specification

Max User Weight : 397lbs (180kg)

24V ---4A

Step Length : 500-690 mm

Adjustable Step Range : 10

Resistance Level:25

Assembled Dimension : 2120*790*1680 mm