

Инструкция

Гребной тренажер Total Gym Elevate Row ADJ

Полезные ссылки:

[Гребной тренажер Total Gym Elevate Row ADJ - смотреть на сайте](#)

[Гребной тренажер Total Gym Elevate Row ADJ - читать отзывы](#)



CONGRATULATIONS

Thank you for choosing Total Gym products and services.

As one of the most innovative designs for row strengthening, we trust your Total Gym ELEVATE Row ADJ will provide you with unsurpassed service and versatility year after year.

Your ELEVATE Row ADJ is designed on an incline for added resistance incorporated into a traditional cardio workout machine. The smooth “flow of the row” is achieved by two independent moving platforms that result in a consistent load on both the pull and the return. With the ELEVATE Row ADJ, resistance is always in play and adapting to all body sizes, produces very low compression on the joints, especially the lower back. The ELEVATE Row ADJ will strengthen all muscle groups simultaneously while giving you a great cardiovascular workout in a totally different way to train your body.

Your Total Gym product arrives with some assembly required. Simply follow the directions and in minutes your ELEVATE Row ADJ will be operational.

In this Owner's Guide, you will find information about your ELEVATE Row ADJ and its component parts, operation, maintenance and care. Additionally, you will find usage and safety tips, as well as precautions to help ensure the safety of your clients and warranty information. Please save this guide and refer to it in the future.

We value you as a customer and your feedback is important to us. If you have any questions or need further information about your ELEVATE Row ADJ, please contact our customer service department at (858) 586-6080 or email support@totalgym.com.

Yours in health,



Jesse Campanaro
CEO

TABLE OF CONTENTS

Safety Precautions	3
Specifications & Limitations	4
Parts Identifier	5
Assembly & Installation	6-7
Durapro Band	8
Connecting.....	8
Replacing.....	8
Computer Instructions	9
Changing Batteries	9
Seat or Foot Platform: Roller Removal & Assembly	9
Maintenance & Care	10
Getting Started	10
Troubleshooting	10
Warranty Information	11
USA Warranty.....	11
Limited Warranty.....	11
Warranty Claims.....	11

SAFETY PRECAUTIONS

Before starting this or any exercise program, consult your physician, who can assist in planning a program that is age and ability appropriate. Certain exercise programs or types of equipment may not be suitable for all people. Ensure that you or your clients are able to participate in an exercise program on this equipment without injury.

- Do not overexert, or allow exertion using this equipment or performing any exercise program on this equipment. If any pain or tightness in the chest occurs, an irregular heartbeat, shortness of breath, faintness, nausea or dizziness is experienced, stop the exercise session immediately and consult a physician before resuming any exercise program. (Clinicians and trainers should follow these recommendations if these symptoms are observed in clients.)
- Clinicians and trainers should inform clients of and monitor their adherence to all safety precautions. Use only as instructed.
- Do not permit anyone to stand on any part of the Total Gym ELEVATE Row ADJ or use it as furniture. Children should only use the ELEVATE Row ADJ when closely attended and supervised by an adult. Do not leave children or clinical patients unattended on Total Gym equipment.
- Parents and others in charge of children should responsibly monitor children whose natural play instinct and fondness of experimenting can lead to situations and behavior for which the training equipment is not intended.
- If children are allowed to use the equipment, their mental and physical development and above all their temperament should be taken into account. They should be controlled and instructed in the correct use of the equipment.
- The equipment is under no circumstances suitable as a children's toy.
- Keep fingers, loose clothing and hair away from moving parts. Wear appropriate exercise attire and tie long hair back.
- Inspect your ELEVATE Row ADJ before each use to ensure proper operation. Check all parts for wear before each use. Do not use your ELEVATE Row ADJ if it is not completely assembled or if it has been damaged in any manner. Contact Total Gym Customer Service for replacement parts or repairs.

- Follow instructions in this Owner's Guide for using the unit. Improper use could result in severe or fatal injury. Follow all instructions as labeled on unit stickers. The ELEVATE Row ADJ is rated at a maximum user weight capacity of 400 lbs. [180 kg.].

⚠ WARNING

READ ALL INSTRUCTIONS BEFORE USING TOTAL GYM ELEVATE ROW ADJ.

1. Inspect your ELEVATE Row ADJ before each use to ensure proper operation. Do not use this equipment unless all moving parts are working properly. Follow all maintenance and care instructions found in this Owner's Guide and on the equipment labels.
2. Care should be taken at all times when getting on and off your ELEVATE Row ADJ or any exercise equipment. Falling on or off the product could result in injury, or possibly death. Follow the "Getting Started" instructions for using the unit found in this Owner's Guide.
3. Use your ELEVATE Row ADJ only for its intended use.
4. Keep fingers, loose clothing and hair away from all moving parts.
5. As a facility offering the use of the ELEVATE Row ADJ to customers, or as a personal user of the product, you – the owner of the product – assume the responsibility to become familiar with the guidelines relative to safe use of the product and to convey these guidelines to all users. Read all safety, warnings and usage instructions before using the ELEVATE Row ADJ. Care and maintenance for this product are included to promote safe, enjoyable use of this equipment.
6. Usage Class: Class S per ISO 20957, 60335
Compliant to the General Product Safety
Directive 2001/95/EC and ASTM-F2276



The ELEVATE Row ADJ has been tested to comply with CE and other safety standards.

SPECIFICATIONS & LIMITATIONS

- Weight Capacity: Maximum user weight capacity of 400 lbs [181 kg]
- In Use: 98" x 33" x 42" (L/W/H) [249 x 84 x 107 cm]
- Unit Weight: 106 lbs [48 kg]
- Freight Weight: 150 lbs [68.04 kg]
- Freight Dimensions: 82" x 27" x 17" (L/W/H) [209 x 69 x 43 cm]
- Glideboard Range of Motion: 46" [117 cm]
- Floor Space Required: 12 square feet [1.1 square meters]
- Construction: Steel with steel reinforced extruded aluminum rails
- Keep side areas clear 1.96' [0.6 m] or more.

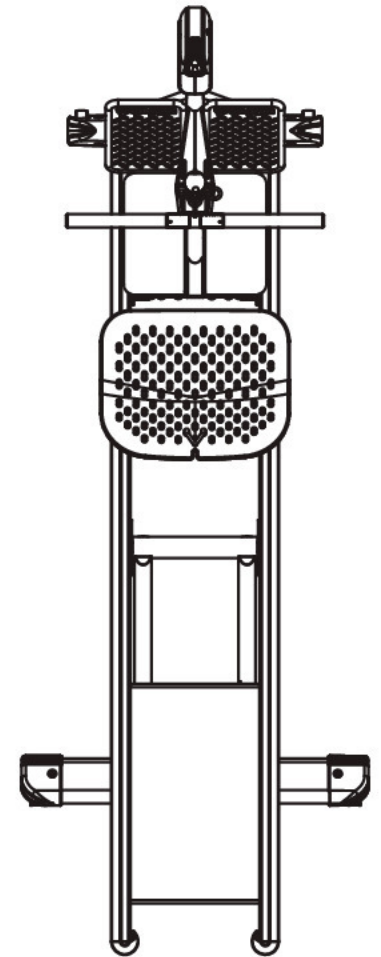
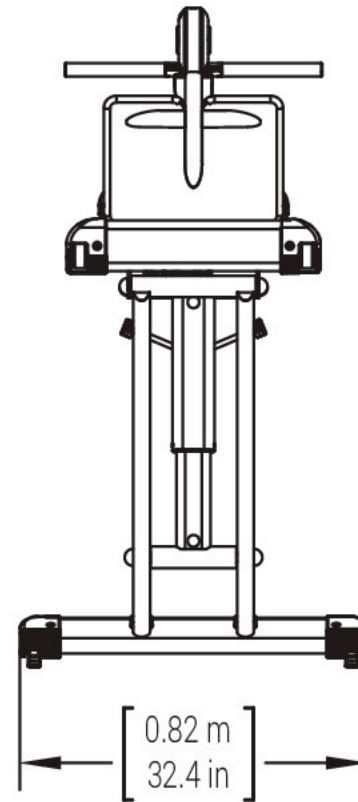
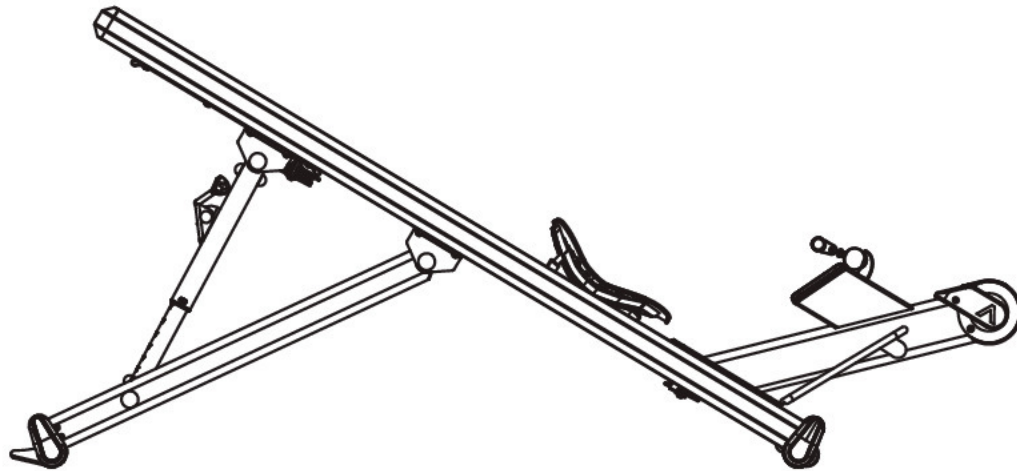

PARTS IDENTIFIER

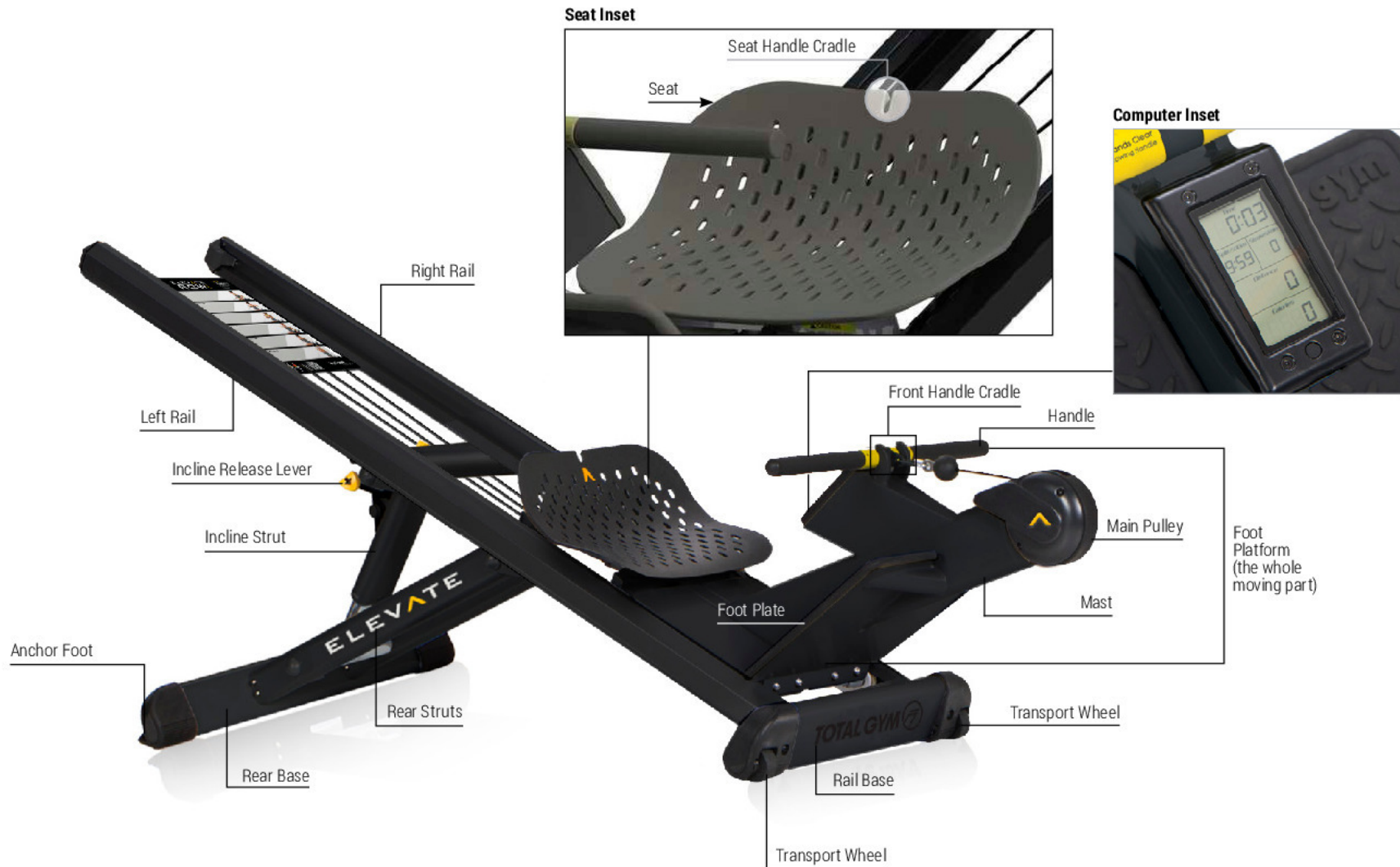

ASSEMBLY & INSTALLATION

TWO PERSON ASSEMBLY REQUIRED.

STEP 1. Remove all the top styrofoam. Carefully unpack all parts and Information & Hardware box at the installation site if possible. You will find three separate sets as shown below.



A Rear Struts & Incline Strut



B Rear Base



C Rail Assembly

STEP 2. Cut tie wraps and remove the rest of the packing material except for ones clearly marked "DO NOT REMOVE until rotating the mast".

STEP 3. Open the Information & Hardware box. Inside there will be:

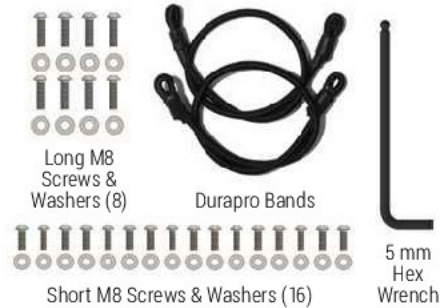

STEP 4. NOTE: This step requires two people. Lift **C** and turn it upside-down. Be careful to make sure the mast is still in between the rail.

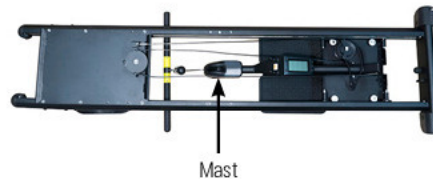

Mast

STEP 5. Attach **B** to **A** as shown. Using the 5 mm Hex Wrench install all eight Short M8 screws with washers. Do not tighten completely until all eight screws have been installed.

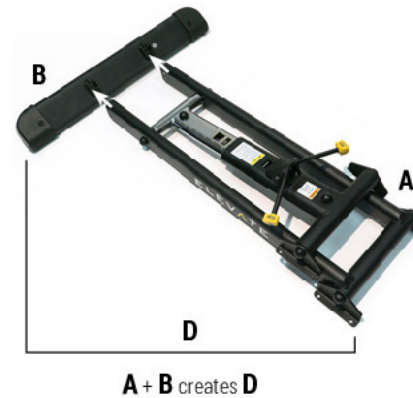

A + B creates D

STEP 6. Now that you have assembled **A** and **B** to create **D** as shown in **STEP 5**, you will need to take **D** and lay it over the top of **C**. Be sure to place a cloth or packing material between the surfaces.



Using the 5 mm Hex Wrench, attach the hinges on to **C** assembly with four Long M8 screws and washers. Do not tighten any completely until all four screws are installed.

STEP 7. While one person holds the Incline Strut up as shown, the other person aligns the hinges to the set of holes in the rails. Match the letters at each hole to the corresponding letters on the strut so that you know you are connecting the two pieces correctly, and using the 5 mm Hex Wrench install the screws. Do not tighten any completely until all four screws are installed.



STEP 8. NOTE: This step requires two people. Lift and turn the rails back up carefully as the adjustable strut will automatically open.

STEP 9. Next, you will be rotating the mast. Before you do, note the 3 cables that hang below the mast—be sure that they are not being pinched when you rotate the mast further.



Now move the mast as far as it can go.



STEP 10. Now you will install the Foot Platform. Begin on the seat side and install four Short M8 screws and washers - **do not tighten all the way.**

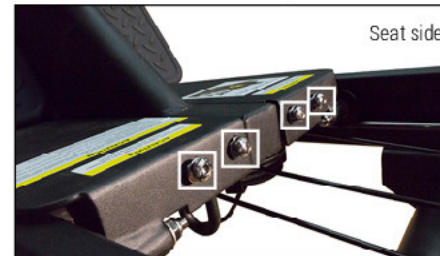

Take the handle and rest it on top of the end of the rail as shown below.



Install four Short M8 screws and washers on the floor side. Tighten all screws.



STEP 11. Position your ELEVATE Row ADJ in a permanent location then bolt to floor from the Anchor Feet as shown below. **Bolts not included.**



STEP 12. Set the handle on to the handle cradle. Your new ELEVATE Row ADJ is now ready to use. **OPTION:** Please see "Durapro Band: Adding & Replacing" in next column adding the resistance band for additional resistance.

DURAPRO BAND

CONNECTING THE BAND BEFORE FIRST USE

STEP 1. Connect one end to the front stabilizer.

STEP 2. Make sure the band follows the direction shown around the pulley.

STEP 3. Attach the second end to the hook mounted to the front of the platform.

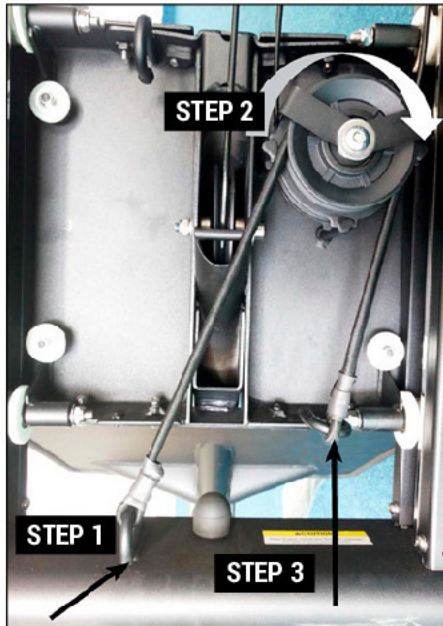

REPLACING THE BAND

STEP 1. Adjust the rail height to highest level.

STEP 2. Next, unhook the bungees from the two hooks.



STEP 3. Get under the rail and loosen the nut on the end of the cable to release tension.



STEP 4. Using a 6mm hex wrench, loosen and remove the screw on the pulley. Be careful as you pull the screw, bracket and pulley off, the cable and pulley will come off of the housing.

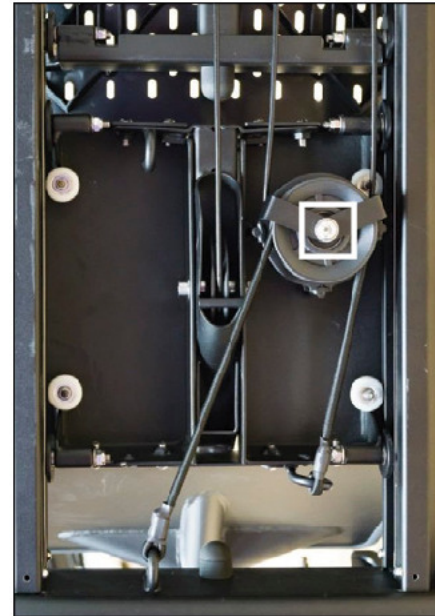

STEP 5. Replace the screw, bracket (make sure the arrow end is pointing downward as shown) and pulley with the new band and tighten the screw.



STEP 6. Attach the cable back and tighten the nut.



COMPUTER INSTRUCTIONS



TO TURN ON: Press the button or start rowing.

TO TURN OFF: Press the button or after 30 seconds of immobility the computer will shut itself off automatically. During those 30 seconds, the computer remains in pause mode. If you continue to row the computer will resume from where you left off.

TO RESET: Press the button twice.

CHANGING BATTERIES

The computer runs on two AA batteries. Remove the 4 screws from the front computer display with a Phillips screwdriver. When changing the batteries ensure all wires remain intact. Carefully tuck the wires into the back of the housing and replace the front display when complete.

Battery Life = approximately 1 year for home use, 6 months for commercial use.

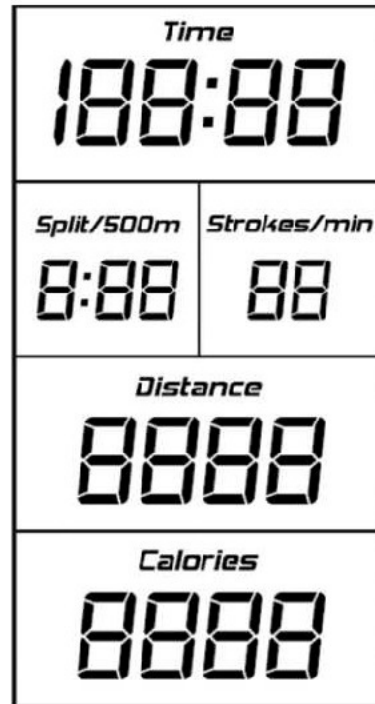

Time = Total Time

Split = Minutes per 500 meters

Stroke = Strokes per minute

Distance = Total distance

Calories = Total calories burned

SEAT OR FOOT PLATFORM: ROLLER REMOVAL & ASSEMBLY

STEP 1. Using a 4 mm Hex wrench, remove the 6 M6 screws (3 on each side) from the rail endcaps.

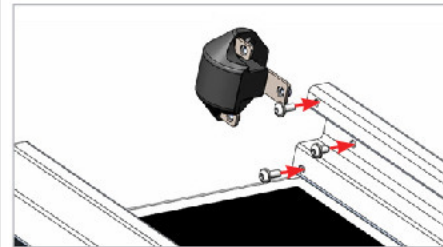

STEP 2. Roll the seat up and off the end of the rails. Then roll the foot platform off the end of the rails.

STEP 3. To remove the rollers use a 13 mm socket wrench and a 13 mm open-end wrench.

STEP 4. Insert socket wrench over the bolt on the outside of the roller as you engage the open-end wrench on the nut on the inside of the frame; turn to unscrew.

NOTE: Hex wrench, socket wrench and open-end wrench, not included.

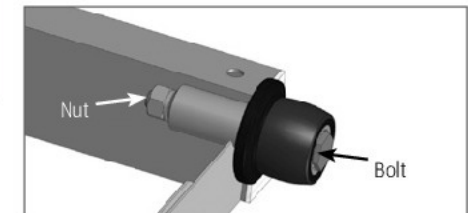

STEP 5. Replace the rollers as needed and reinstall the bolt and nut. Tighten just enough so that the wheel can roll but does not slide lengthwise on the axle. **DO NOT OVER TIGHTEN.**

STEP 6. Return the foot platform back to the unit by rolling it down the rails. Repeat with the seat.

STEP 7. Replace the endcaps on the rails and ensure all 6 screws are tight.

MAINTENANCE & CARE

Your Total Gym ELEVATE Row ADJ will offer you or your facility and your clientele years of easy operation if you follow these simple tips for maintenance and care. With periodic cleaning, moving parts and rolling surfaces will maintain their smooth function. The ELEVATE Row ADJ is not safe to use if it is not maintained regularly as follows. Clean rail surfaces on a regular basis with a noncorrosive cleaner like soap and water or waterless cleaner or just wipe clean with a dry towel. Some black powder residue is normal on the inside of the rails. All other parts can be cleaned the same way or antibacterial wipes may be used. If your ELEVATE Row ADJ is damaged, please discontinue use until defective components are repaired. Please pay special attention to the following wear items: rollers, cables and handle grips.

CAUTION! DO NOT USE ANY LUBRICANTS OR SILICONE-BASED PRODUCTS on the rails or wheels. This will cause the wheels to slide rather than roll and will damage the wheels. You can clean the glideboard material with a non oil-based window cleaner. DO NOT USE ARMOR ALL® OR LIKE SUBSTANCES. These will make the glideboard slippery. Wipe down your ELEVATE Row ADJ with a clean cloth.

MAINTENANCE SCHEDULE

DAILY

1. Wipe down all padded surfaces with antibacterial cleanser after each use.
2. Move the glideboard up and down rails to ensure smooth rolling. If glideboard does not roll smoothly, clean rails and wheels thoroughly.

WEEKLY

1. Wipe down rails with a non-corrosive, no alkaline, no alcohol cleanser.
2. Clean all surface areas for aesthetics.
3. Check all screws and fasteners to ensure they are installed correctly and tightened.
4. Check all pads, fabric or foam for punctures or wear and replace as needed.

MONTHLY

1. Visually inspect the rollers. Clean any debris accumulated on the roller.
2. Inspect rubber stoppers, bungee and computer.

GETTING STARTED

⚠ WARNING

Do not let go of the handle during any part of the exercise.

PLEASE NOTE: The ELEVATE Row ADJ is a different way to row, allowing you to pull at your own pace. Regardless of speed, you will experience the same amount of resistance through a fully distributed strengthening stroke. Designed for both simultaneous concentric and eccentric movements, the ELEVATE Row ADJ provides a compound range of motion to the upper and lower body reducing the traditional "recovery" to a minimum.

When using your ELEVATE Row ADJ, wear athletic shoes and comfortable lightweight clothing. Before you begin, check to ensure that all parts are in place and working properly. Begin your exercise program with the basic moves provided. As your proficiency increases, adjust your body position to increase the intensity.

TROUBLESHOOTING

Please try to solve any issues yourself before calling Total Gym Customer Service at 1-858-586-6080.

1. No display on computer when rowing: Check batteries first then call customer service
2. Seat or foot platform doesn't roll smoothly or quietly: Clean rails and roller; check tightness or roller axles; if problem persists call customer service
3. Pop Pin does not stay in or work properly: Call customer service.
4. Cable or pulley pulls are stiff or sticking or appear damaged: Call customer service.
5. Odd noises or sturdiness changes are noticed from beginning of use: Call customer service.

WARRANTY INFORMATION

US WARRANTY

Warranties outside the US may vary. Contact your local authorized distributor for details.

Commercial Warranty:

- Frame – 5 years
- Parts – 1 year
- Rubber – 1 year

LIMITED WARRANTY

IMPROPER USE OF ELEVATE ROW ADJ: Defects or damages that result from improper use are excluded from coverage.

UNAUTHORIZED SERVICE OR MODIFICATION: Defects or damages that result from service, maintenance, repairs, adjustment, installation or alteration conducted by anyone other than Total Gym or its authorized representatives are excluded from coverage.

WARRANTY CLAIMS

Total Gym treats warranty claims as a priority. To process these quickly, a Return Merchandise Authorization (RMA) number is required to properly link your merchandise with your claim. Total Gym does not accept returned merchandise without an accompanying RMA number. Contact Total Gym Customer Service Department at 858-586-6080 if you are making a warranty claim. A representative will issue you an RMA number and instructions for proper packaging of the equipment for shipping.

IMPORTANT: Save your invoice. Please retain packaging instructions. US Customer Service Center: 858-586-6080. Shipping Damage: FOB origin, unless otherwise specified.

Total Gym accepts no responsibility for damage in shipping. Total Gym does, however, make every effort to facilitate the satisfactory resolution of claims made against delivery agents for damage during shipping. If the package appears to have sustained damage in shipping, or if the ELEVATE Row ADJ appears to have shifted in delivery but no damage is evident, retain the shipping boxes until the ELEVATE Row ADJ has been fully assembled to ensure there is no functional damage that is not initially visible. In the event of damage during shipping, retaining the shipping boxes helps to facilitate your claim against the shipper. Take photographs of damaged boxes or contents before opening.

PURCHASE RECORD. RETAIN THIS COPY FOR YOUR RECORDS.

Date Purchased _____

Purchased From _____

Model Name: ELEVATE Row ADJ, Part # 7450-B1

Serial Number _____

TotalGym.com

Customer Service:
858.586.6080
5225 Avenida Encinas Suite C
Carlsbad CA 92008

TotalGym.com

Customer Service: (858) 586-6080

5225 Avenida Encinas Suite C, Carlsbad CA 92008