

Инструкция

Опция жим ногами Body Solid GLP

Полезные ссылки:

[Опция жим ногами Body Solid GLP - смотреть на сайте](#)

Body-Solid

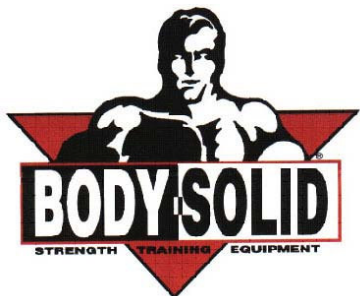
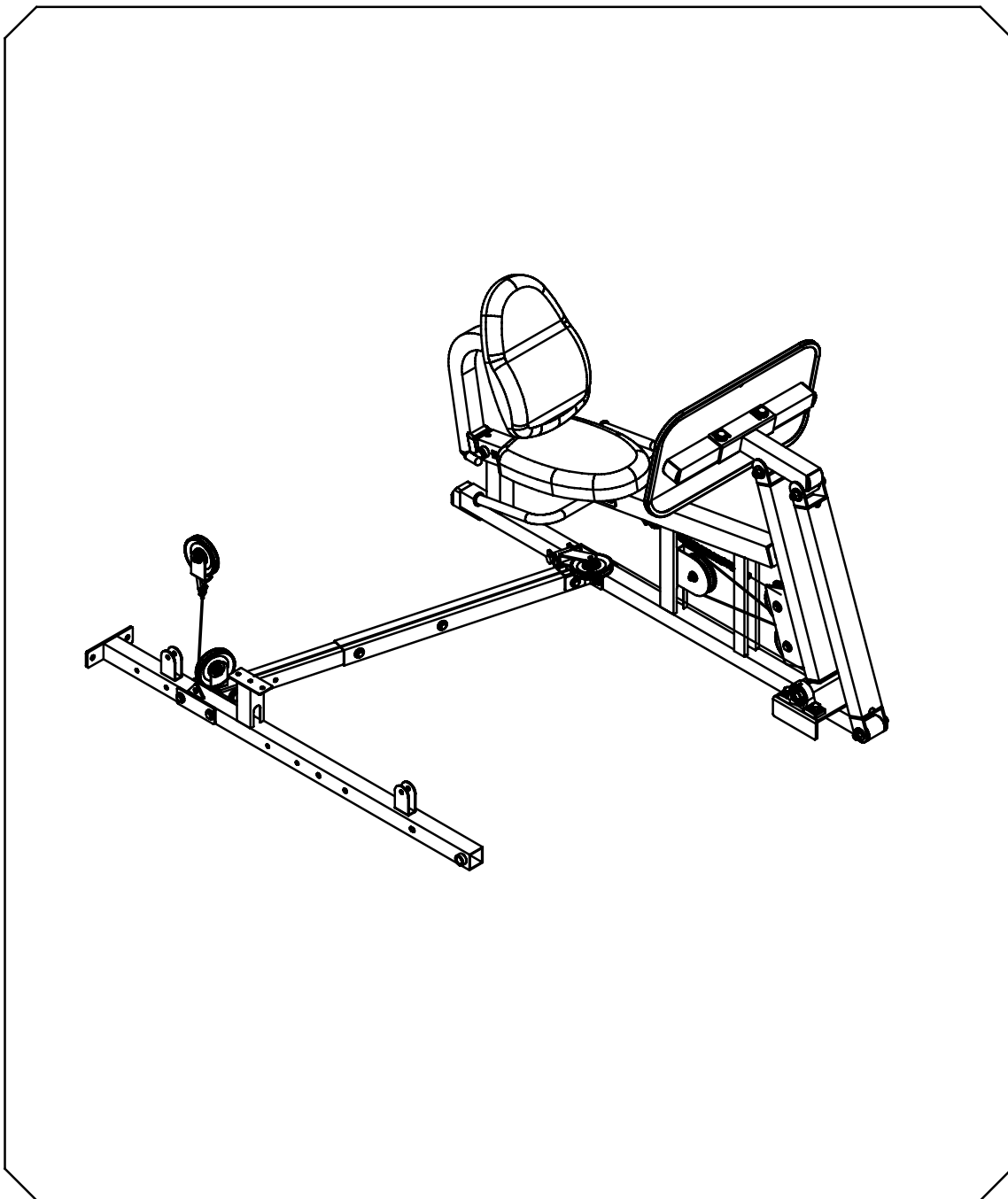

BODY-SOLID, Inc.
1900 S. Des Plaines Ave.
Forest Park, IL 60130 USA
Phone: (708) 427-3555
Fax: (708) 427-3556
www.bodysolid.com

GLP.1 OWNER'S MANUAL

GLP ASSEMBLY INSTRUCTIONS

HARDWARE ILLUSTRATION

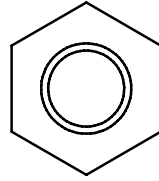
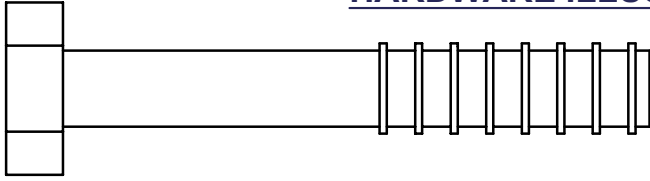

(A1)HEX BOLT 1/2"X3 1/4" PARTIAL THREAD QTY.2

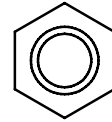
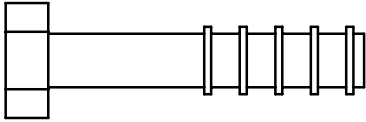

(A2)HEX BOLT 3/8"X1 3/4" PARTIAL THREAD QTY.3

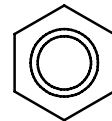
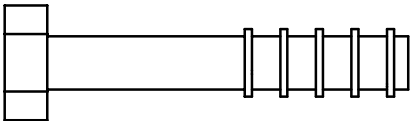

(A3)HEX BOLT 13/8"X2" PARTIAL THREAD QTY.2

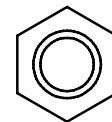
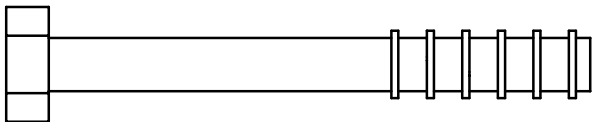

(A4)HEX BOLT 3/8"X3" PARTIAL THREAD QTY.5

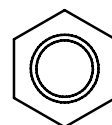
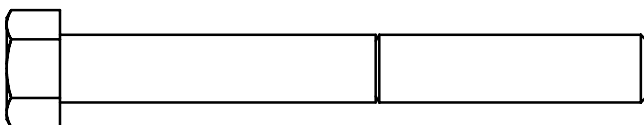

(A5)HEX BOLT 3/8"X3 1/4" PARTIAL THREAD QTY.2

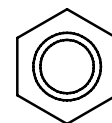
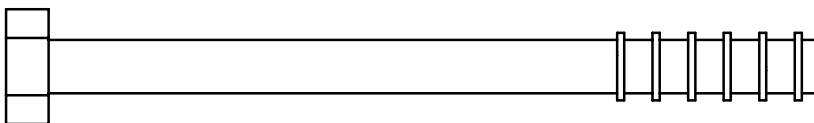

(A7)HEX BOLT 3/8"X4 1/4" PARTIAL THREAD QTY.2

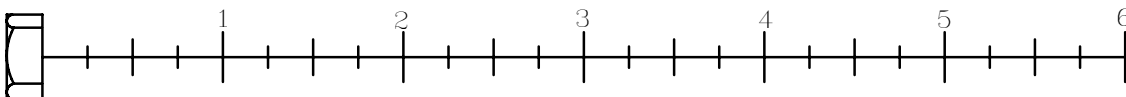

GLP ASSEMBLY INSTRUCTIONS

HARDWARE ILLUSTRATION

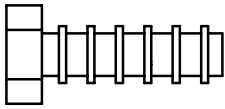

(A8)HEX BOLT 5/16"X1" PARTIAL THREAD QTY.4

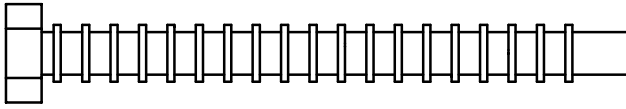
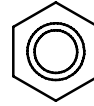

(A9)HEX BOLT 5/16"X3 1/4" PARTIAL THREAD QTY.2

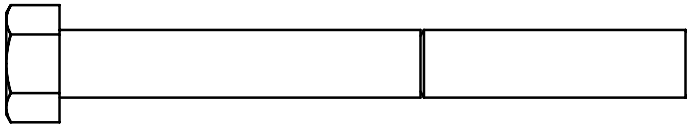
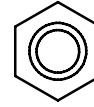

(A10)HEX BOLT 3/8"X2 1/2" PARTIAL THREAD QTY.2

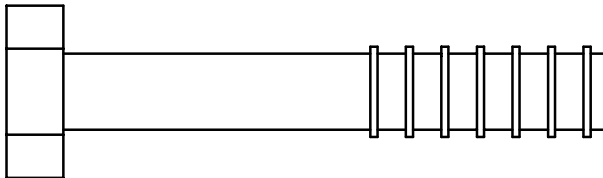
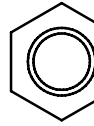

(A11)HEX BOLT 1/2"X3" PARTIAL THREAD QTY.1

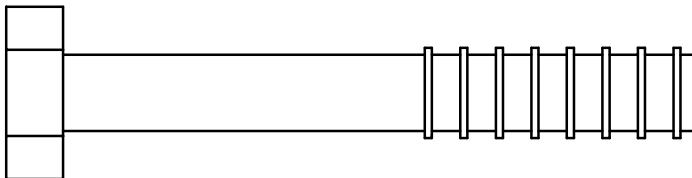
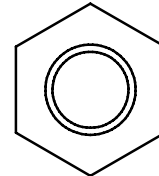

(A12)HEX BOLT 1/2"X3 1/2" PARTIAL THREAD QTY.1

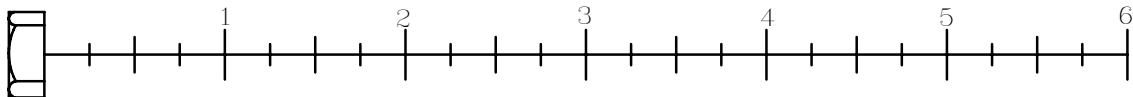
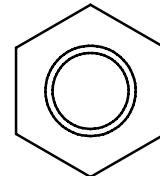

GLP ASSEMBLY INSTRUCTIONS

HARDWARE ILLUSTRATION

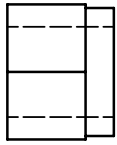

(B1) NYLON LOCK NUT 1/2" QTY.4

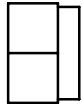
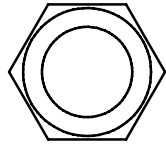

(B2) NYLON LOCK NUT 3/8" QTY.16

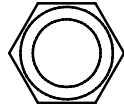

(C4) 5/16"(I.D.) FLAT WASHER Ø24 QTY.6

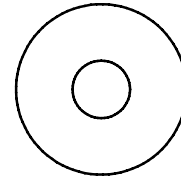

(C5) 1/2"(I.D.) FLAT WASHER Ø25 QTY.4

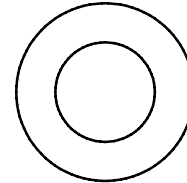

(C1) 1/2"(I.D.) FLAT WASHER Ø34 QTY.6

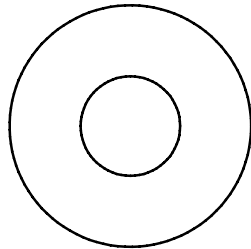

(C2) 3/8"(I.D.) FLAT WASHER Ø27 QTY.32

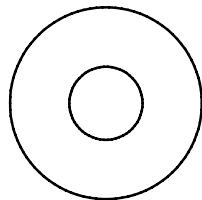

(C3) 5/16" SPRING WASHER QTY.6

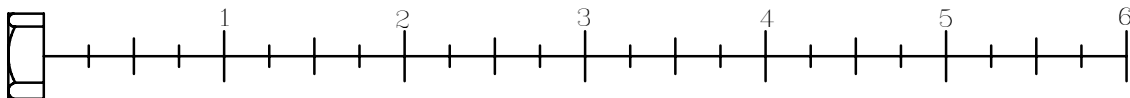

GLP ASSEMBLY INSTRUCTIONS

HARDWARE ILLUSTRATION

- D1. $\varnothing 6$ Spring Snap Link (8810-001)-----[1PCS]
- D2. $\square 50 \times 2.5T$ Round End Cap (9211-088)-----[4PCS]
- D3. 2"x2" Foot Cap (9211-025)-----[1PCS]
- D4. 45X60 Nylon Bushing (9211-047)-----[1PCS]
- D6. 45X50 Rubber Dount(9212-039)-----[1PCS]
- D7. $\varnothing 1$ Round End Cap (9260-021)-----[2PCS]
- D8. 4205 Steel Cable-----[1PCS]
- D9. $\varnothing 4$ 1/4" Pulley(9213-002C)-----[5PCS]

D1

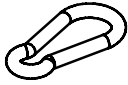

D2



D3

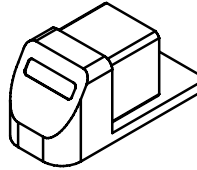

D4

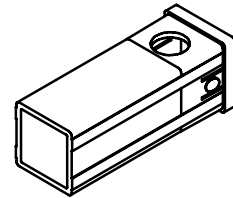

D6

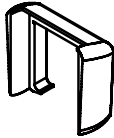

D7

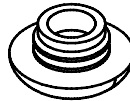

D8



D9

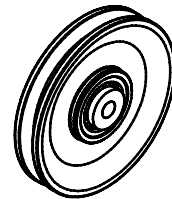

GLP ASSEMBLY INSTRUCTIONS

PARTS ILLUSTRATION SHEET

A1[1PCS]

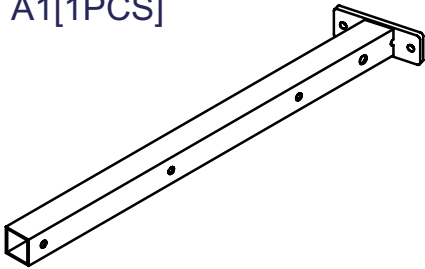

B[1PCS]

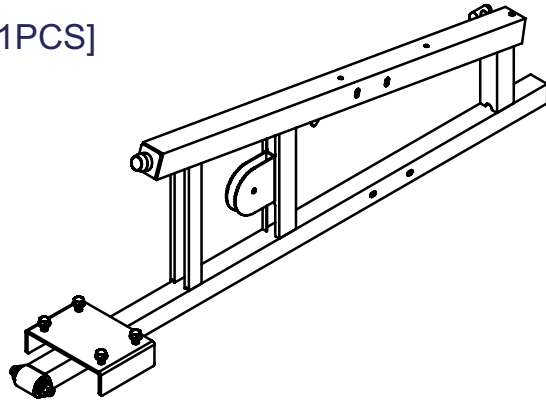

C[1PCS]

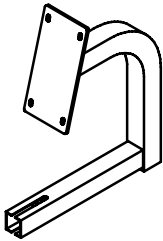

D[1PCS]

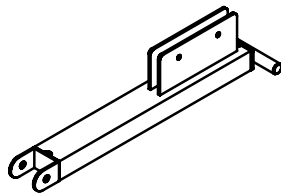

E[1PCS]

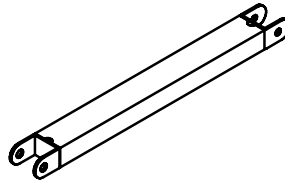

F[1PCS]

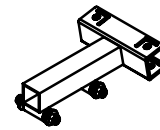

G[1PCS]

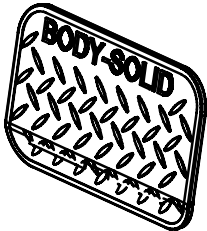

H[2PCS]

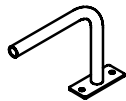

J[2PCS]
8312-090

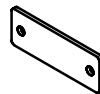

K[2PCS]
8510-005

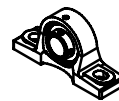

L[1PCS]
9121-045

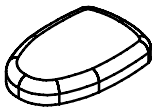

M[1PCS]
9111-049

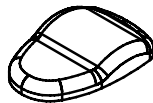

N1[1PCS]

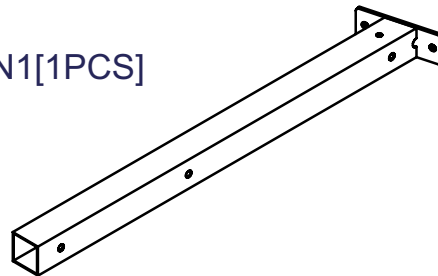

O[1PCS]



P[1PCS]



Q[1PCS]



GLP.1-122005

IF Mode A: □50X50 Steel Tube
 uses A4 Bolt for G2B,G3S,G6B,G5S--(2PCS each)

IF Mode B: □50X75 Steel Tube
 uses A7 Bolt for G4I,G10B--(2PCS each)

Mode B:50X75 Steel Tube

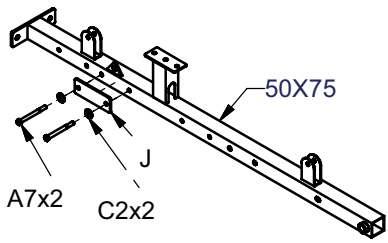

Please adjust the length between A1 to N1
 approximately to 1112mm
 Suitable TO model:G6B,G5S,G10B

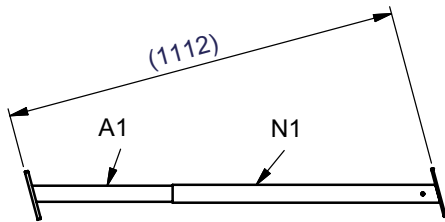

Please adjust the length between A1 to N1
 approximately to 862mm
 Suitable TO model:G2B,G3S,G4I

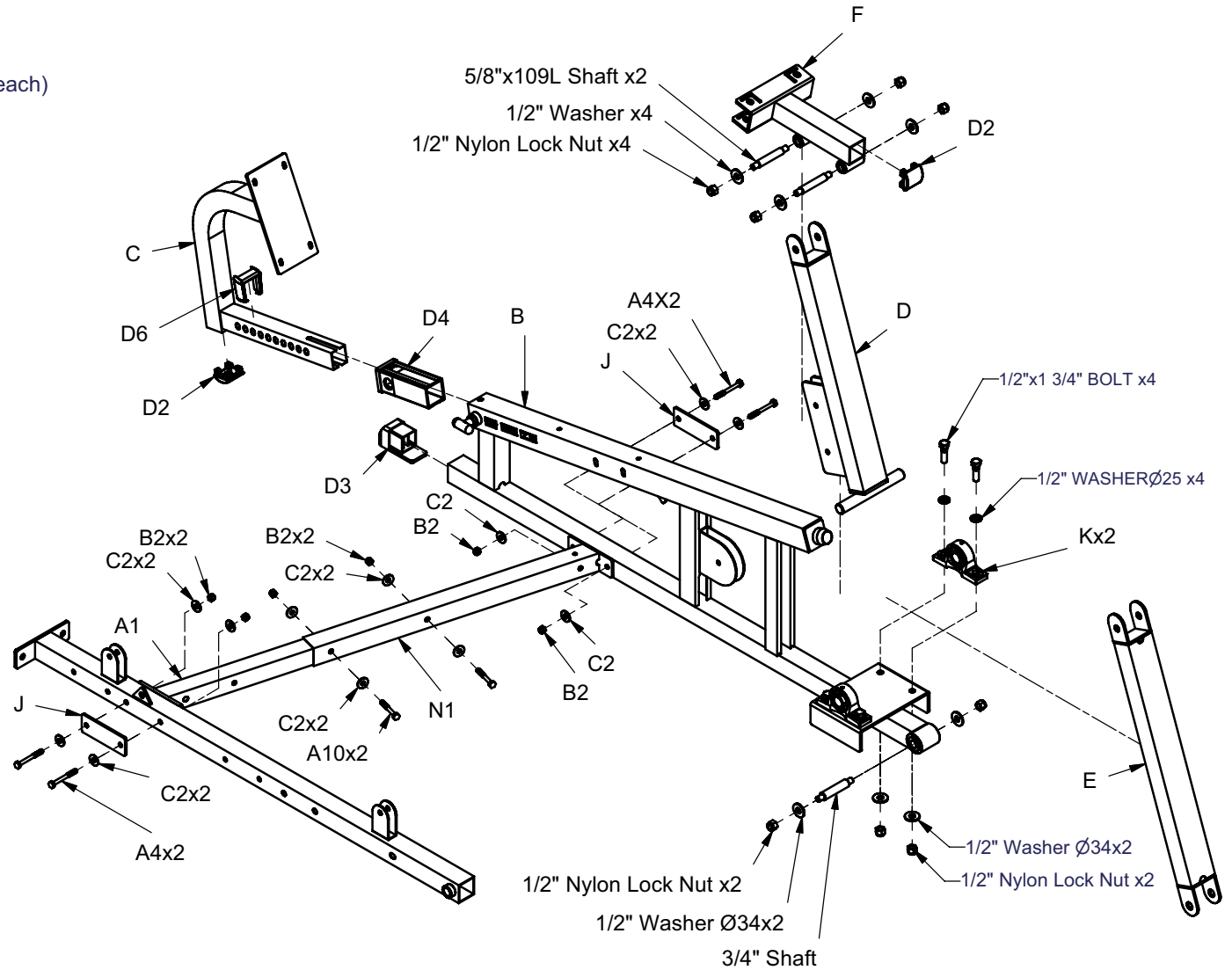
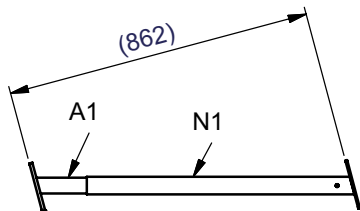

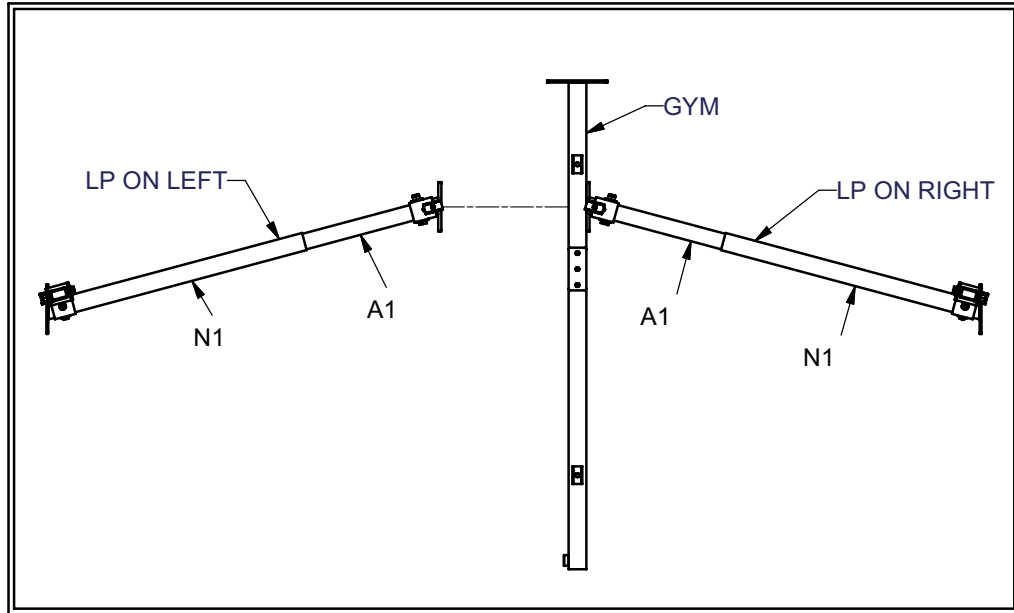
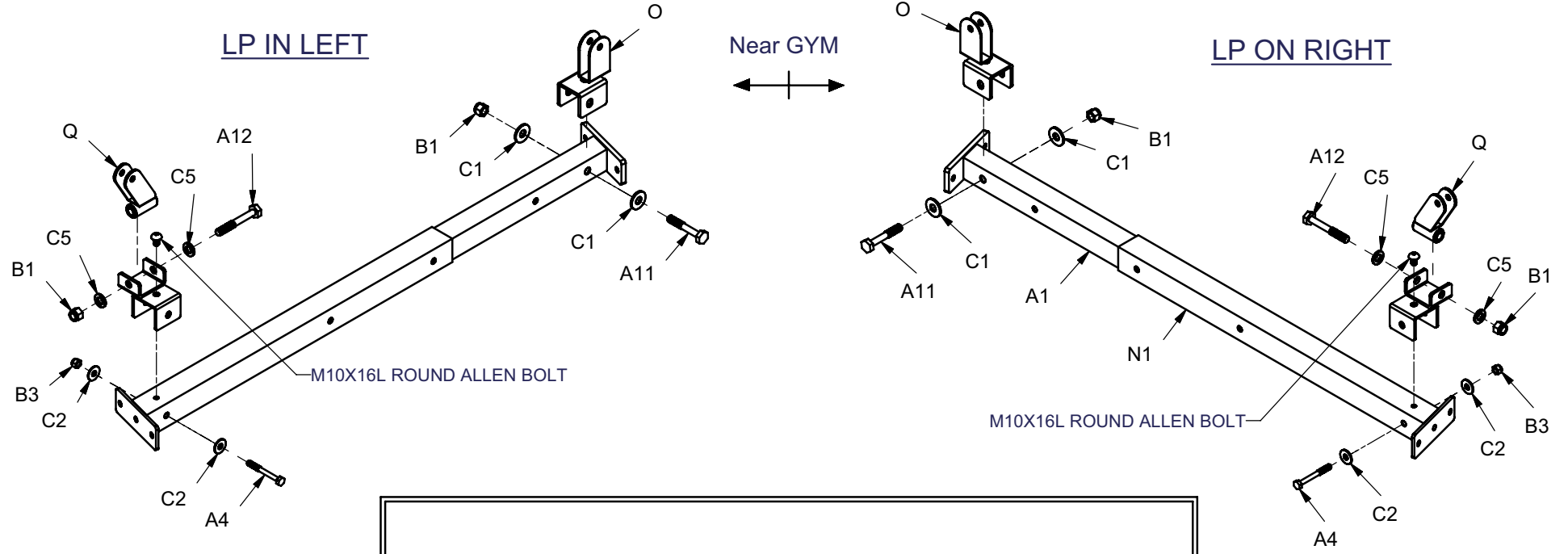

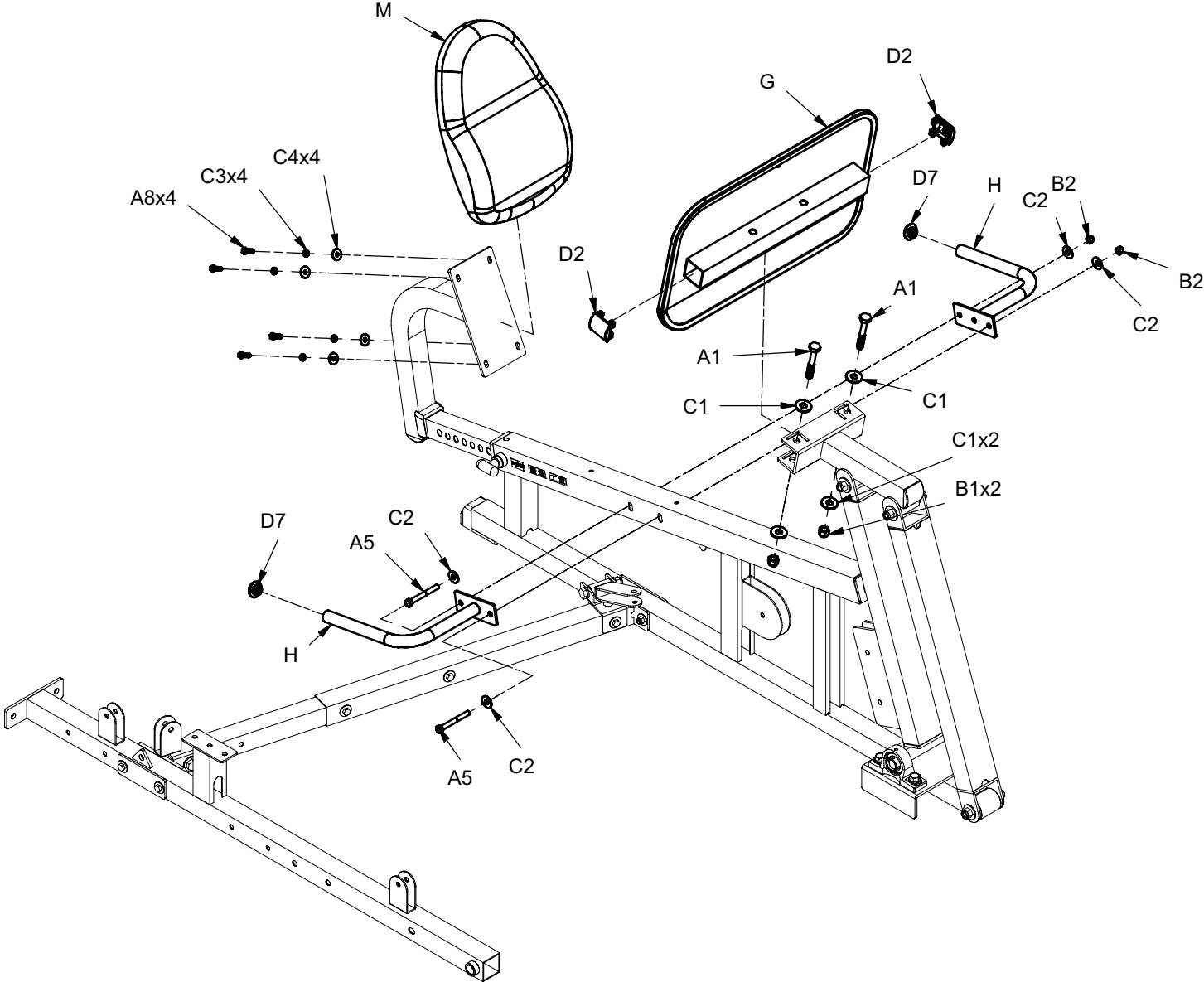

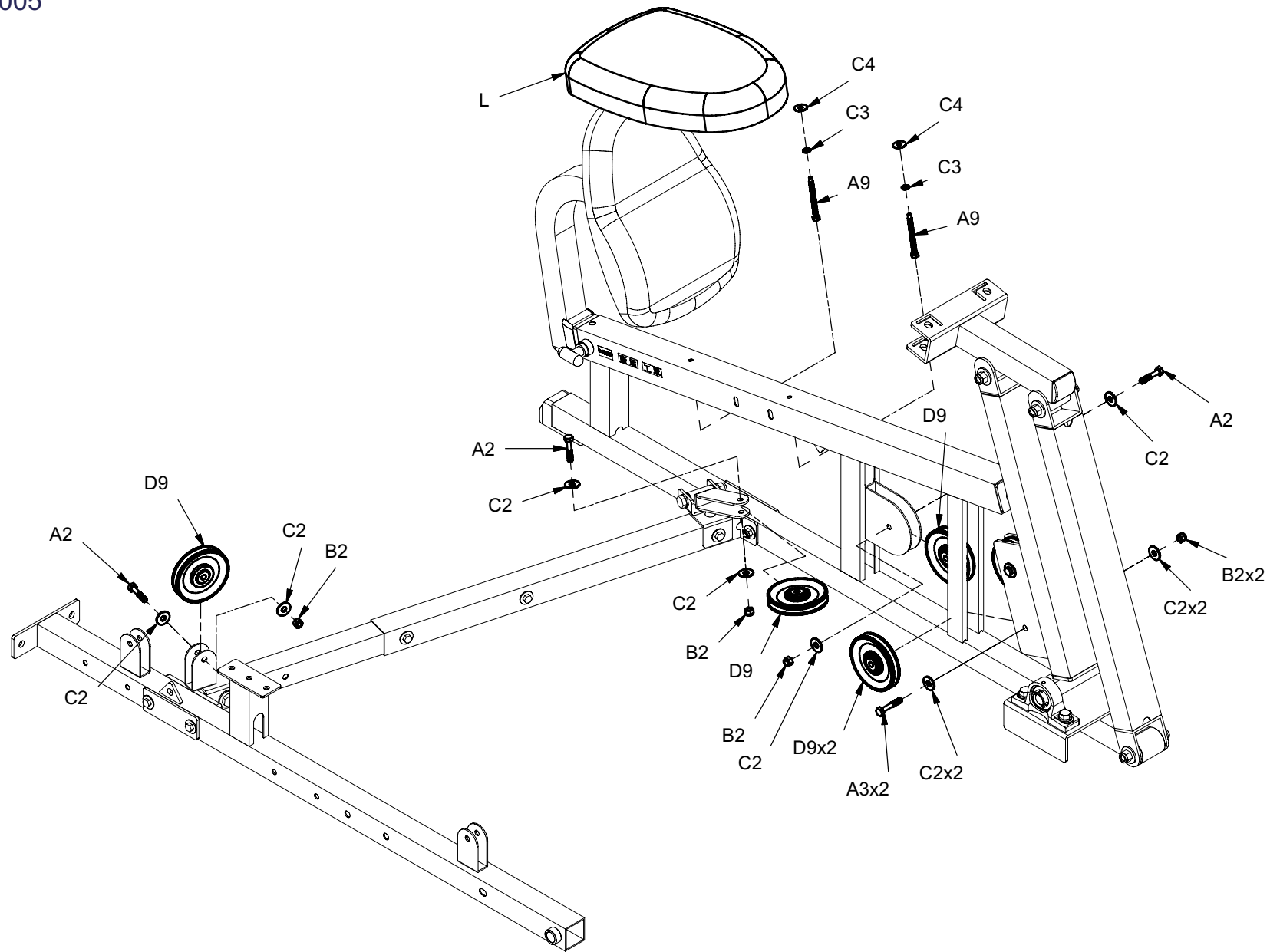

GLP.1-122005

D8 

Suitable to model:G2B,G3S,G4I

Suitable to model:G6B,G5S,G10B

