

Инструкция

Жим от плеч Body Solid ProClub SSP-800

Полезные ссылки:

[Жим от плеч Body Solid ProClub SSP-800 - смотреть на сайте](#)

[Жим от плеч Body Solid ProClub SSP-800 - читать отзывы](#)

SBP-100G CHEST PRESS

THERE IS A RISK ASSUMED BY INDIVIDUALS WHO USE THIS TYPE OF EQUIPMENT. TO MINIMIZE RISK, YOU MUST FOLLOW THESE RULES:

1. **Inspect equipment before each workout. Check that all nuts, bolts, screws and pop pins are in place and fully tightened. Also, before use, check cables for signs of wear. Replace all worn parts immediately. Never use machine if any parts are damaged or missing. Failure to follow these rules may result in serious injury.**
2. **Keep clear of the cables and all moving parts when the machine is in use.**
3. **Always make sure all Snap Links are closed when doing any cable/pulley exercises.**
4. **Exercise with care. Perform your exercises at a smooth moderate pace; never perform jerky or uncoordinated movements that may cause injury.**
5. **It is recommended that you should workout with a training partner.**
6. **Do not allow children or minors to play on or around this equipment.**
7. **If unsure of proper use of equipment, call your local Body-Solid distributor or the Body-Solid customer service department at 1-800-556-3113.**
8. **WARNING: Consult your physician before starting your exercise program. For your own safety, do not begin any exercise program without proper instruction.**



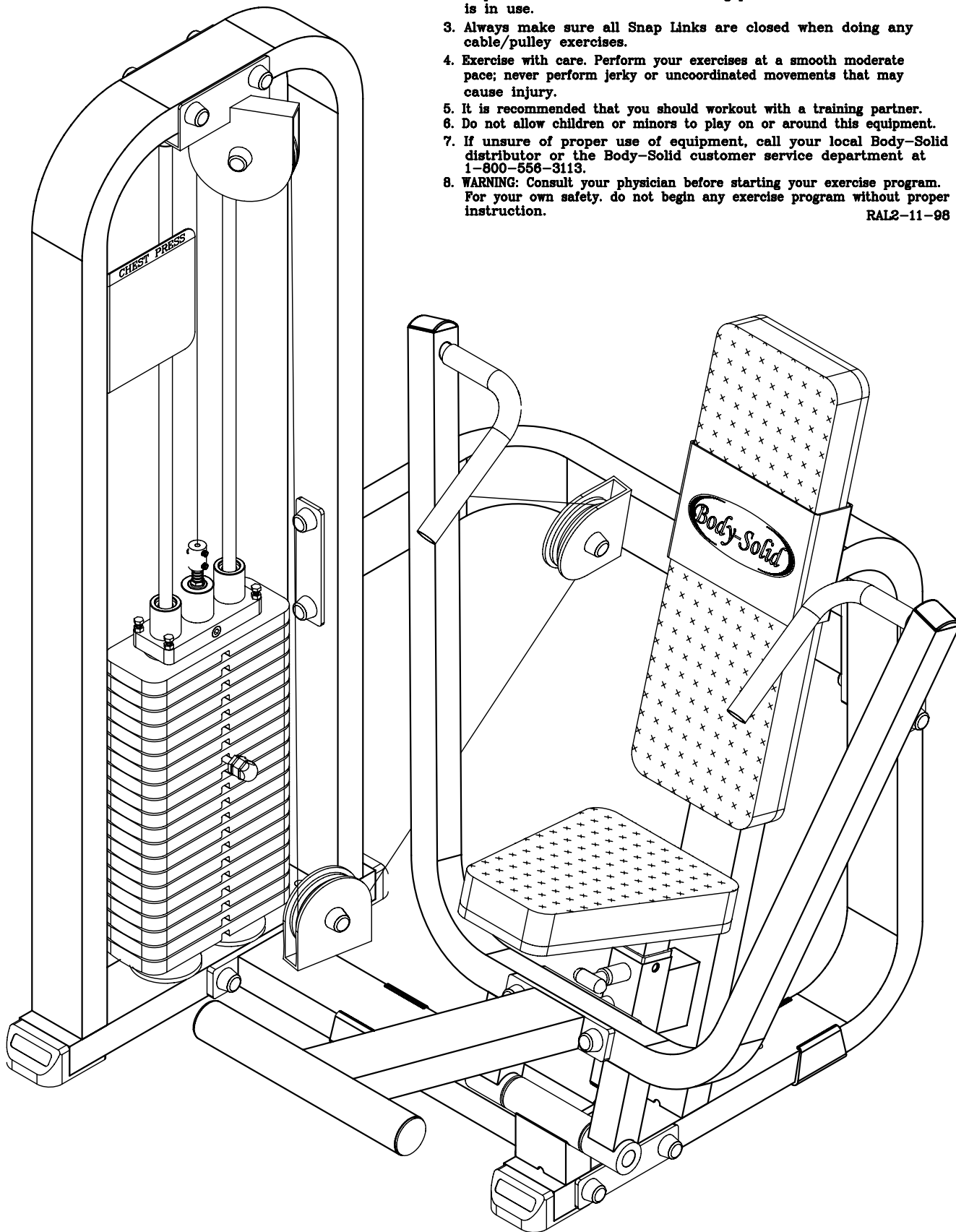







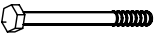
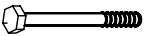





RAL2-11-98

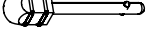













VERSION 200505

SBP-100G

HARDWARE ILLUSTRATION SHEET

	Qty.
 A1. 1/2"X5 1/2" HEX HEAD BOLT -----	[6PCS]
 A2. 1/2"X5" HEX HEAD BOLT -----	[3PCS]
 A3. 1/2"X3 1/2" HEX HEAD BOLT -----	[4PCS]
 A4. 1/2"X2 1/4" HEX HEAD BOLT -----	[3PCS]
 A5. 5/16"X3" HEX HEAD BOLT -----	[1PCS]
 A6. 5/16"X1 1/4" HEX HEAD BOLT ---	[6PCS]
 A7. 7/16"X1 1/2" ROUND BOLT -----	[1PCS]
 A8. 5/16"X3/8" SET SCREW -----	[3PCS]
 A9. 5/8" ROUND BOLT -----	[1PCS]
 A10. 10LB BALL PIN -----	[1PCS]
 A11. 3/8"X1 1/2" ROUND BOLT -----	[1PCS]
 B1. 1/2" NYLON LOCK NUT -----	[16PCS]
 B2. 5/8" LOCK NUT -----	[1PCS]
 B3. 3/8" NYLON LOCK NUT -----	[1PCS]
 C1. 1/2" ROUND END CAP WASHER --	[32PCS]
 C2. 5/16" (I.D)WASHER -----	[7PCS]
 C3. 5/16" SPRING WASHER -----	[7PCS]
 C4. 5/8" SPRING WASHER -----	[1PCS]

	Qty.
 D1. 1/2" BOLT CAP -----	[32PCS]
 D2. 2"X4" END CAP (9211-014)-----	[1PCS]
 D4. 2"X2"X1.8t END CAP (9211-087)----	[3PCS]
D5. 60X50 NYLON BUSHING (9211-033)---	[2PCS]
D6. ø1" RUBBER STOPPER (9212-019) --	[1PCS]
 D7. ø4" RUBBER DONUT (9310-017)---	[2PCS]
 D8. ø6" PULLEY (9213-009)-----	[1PCS]
 D9. ø4 1/2" PULLEY (9213-010)-----	[2PCS]
 D10. ø3/4" SHAFT COLLAR (9211-046)---	[2PCS]
 D11. 2"X4" RUBBER DOUNT (9212-009)---	[2PCS]
D12. 150X245 NO-SLIP TAPE (9310-036)	[1PCS]
D13. 95X140 NO-SLIP TAPE (9310-035)	[2PCS]
 D14. CHROME TOP PLATE (8400-002)---	[1PCS]
 D15. WEIGHT SELECTOR BAR (8220-060)	[1PCS]
D16. STEEL CABLE -----	[1PCS]
 D17. 2"X4" FOOT END CAP (9211-028)---	[3PCS]
 D18. ø5/8" ROUND END CAP (9211-015)-	[4PCS]

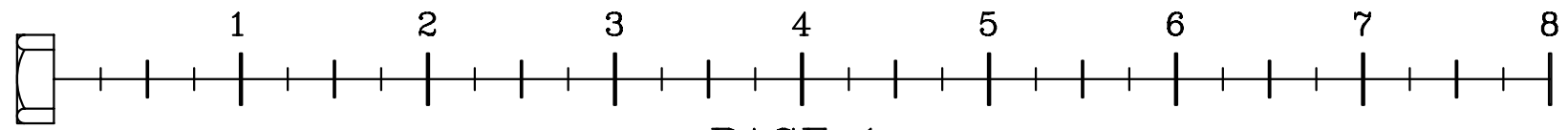
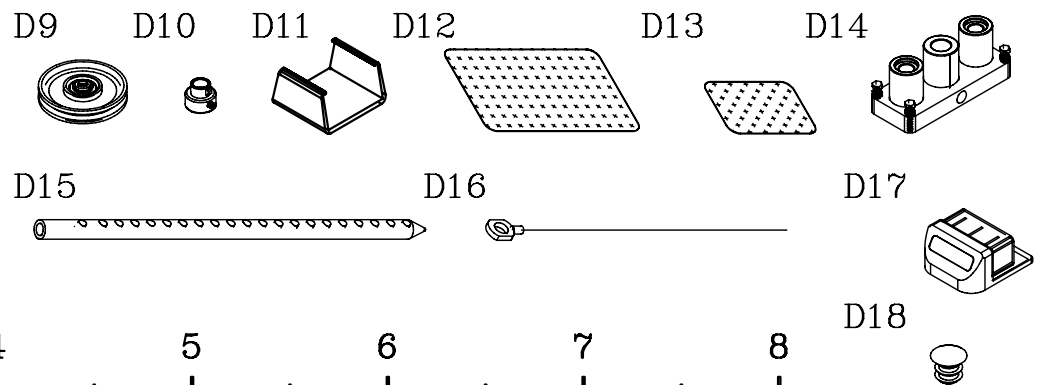

SBP-100G

PARTS ILLUSTRATION SHEET

A [1PCS] WEIGHT STACK FRAME

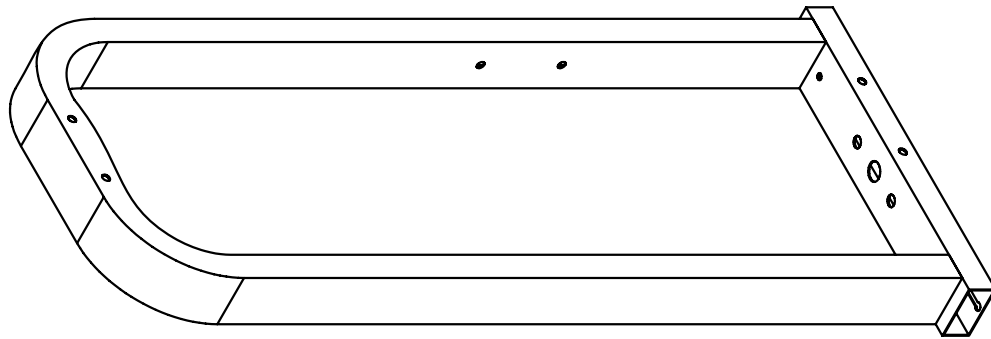

D [1PCS] MAIN BODY FRAME

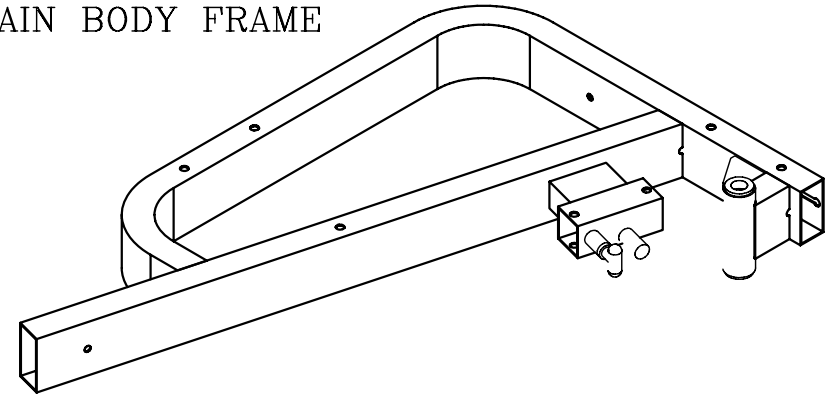

B [1PCS] MIDDLE PULLEY FRAME

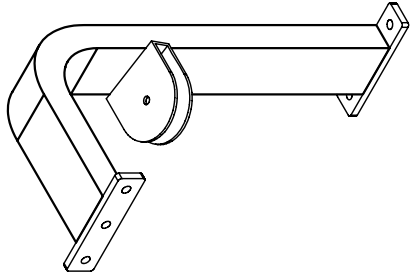

E [1PCS] PRESS ARM FRAME

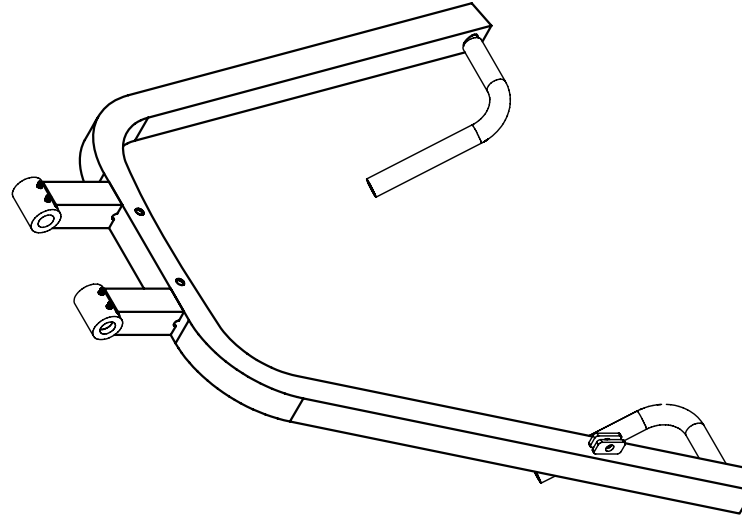

F [1PCS] KICK-ASSIST FRAME

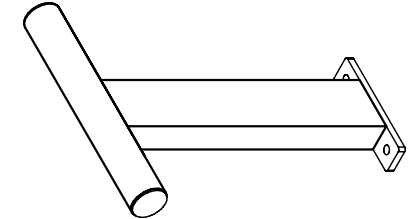

C [1PCS] BOTTOM PULLEY FRAME

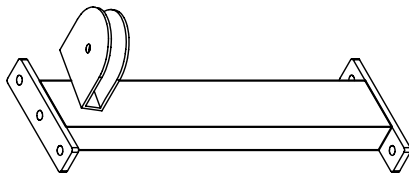

G [1PCS] SEAT FRAME

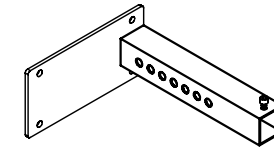

H [1PCS] TOP PULLEY FRAME

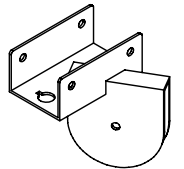

I [2PCS] CHROME GUIDE ROD

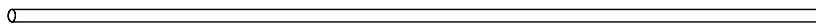

K [5PCS] 2"X8" PLATE



L [2PCS] PAD BRACKET



M [1PCS] BACK PAD

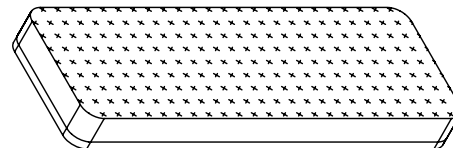

N [1PCS] SEAT PAD

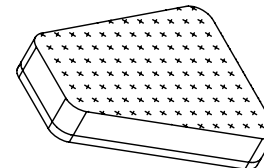

O [1PCS] BACK PAD RUBBER

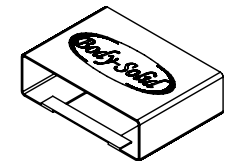

SBP-100G

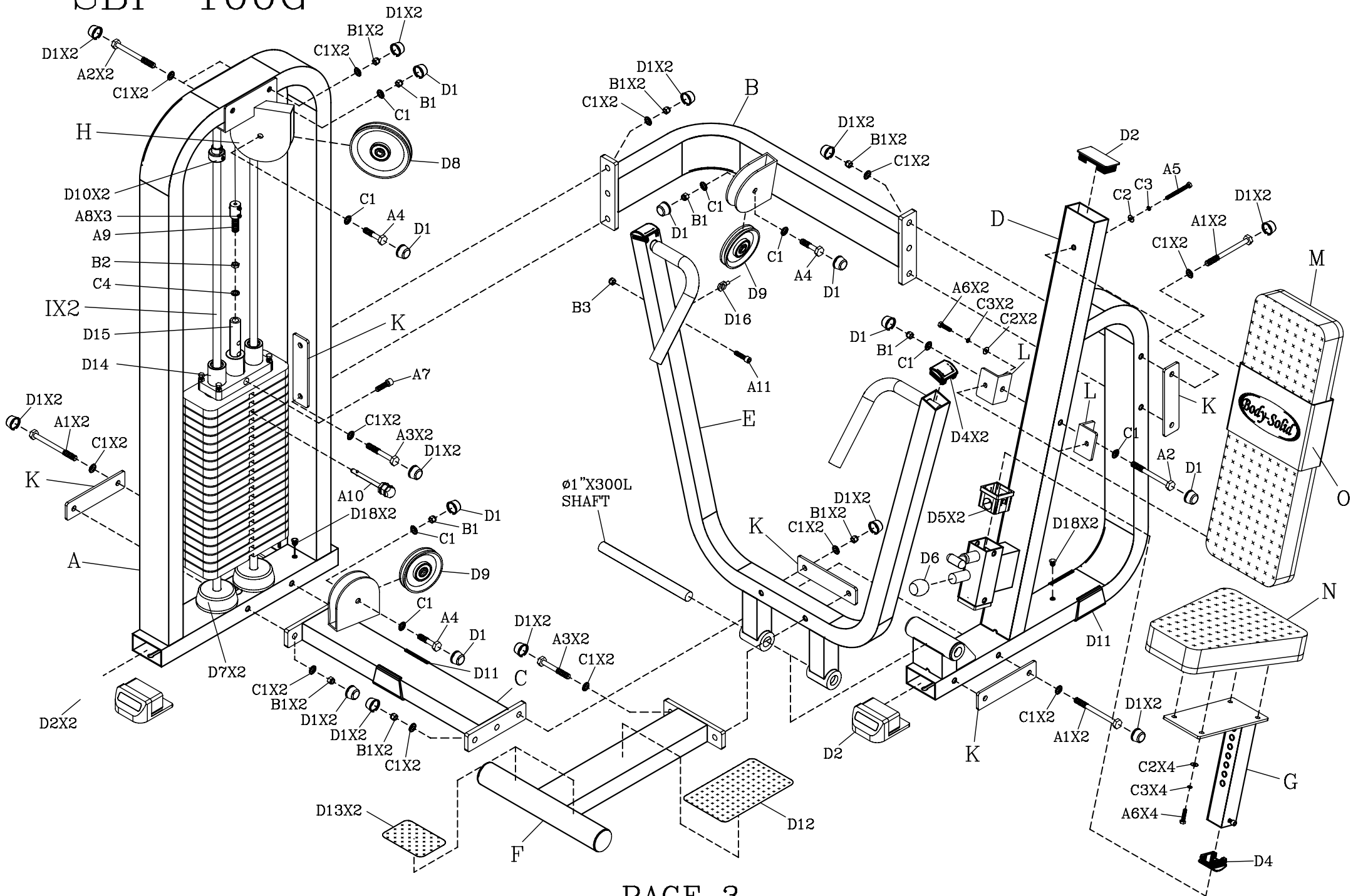

SBP-100G CHEST PRESS ASSEMBLY STEPS

STEP-1

NOTE: DO NOT TIGHTEN AND BOLTS SECUREY UNTIL.
YOU HAVE COMPLETED ALL ASSEMBLY STEPS.

- Attach A Weight Stack Frame and D Main Body Frame to C Bottom Pulley Frame.
- Attach B Middle Pulley Frame to A Weight Stack Frame and D Main Body Frame.
- Attach E Press Arm Frame to D Main Body Frame.
- Attach F Kick-Assist Frame to E Press Arm Frame.

STEP-2

- Attach I Chrome Guide Rods and D7 Rubber Donuts to A Weight Stack Frame.
- Slide Weight Stack and D14 Chrome Top Plate onto I Chrome Guide Rods.
- Attach H Top Pulley Frame to A Weight Stack Frame and attach D10 Shaft Collar.
- Attach L Pad Brackets to D Main Body Frame.
- Attach M Back Pad to D Main Body Frame.
- Attach N Seat Pad to D Main Body Frame.
- Slide G Seat Frame into D Main Body Frame.

**CAUTION: DO NOT OVERTIGHTEN PAD BOLTS.
OVERTIGHTENING WILL STRIP
T-NUTS IN THE WOOD.**

STEP-3

- Attach Pulleys and Cables as shown.
- Attach End Caps, Grips and No-Slip Tape.
- TIGHTEN ALL NUTS AND BOLTS SECURELY.
- Attach Bolt Caps.

SAFETY RULES

1. Periodically check that all nuts, bolts and screws are fully tightened on your CHEST PRESS MACHINE.
2. Exercise with care. Perform your exercises at a smooth moderate pace; never perform jerky or uncoordinated movements that may cause injury.
3. It is recommended that you should workout with a training partner.
4. Warning: CONSULT YOUR PHYSICIAN BEFORE STARTING YOUR EXERCISE PROGRAM. IT IS ADVISABLE TO HAVE A PHYSICAL EXAMINATION BEFORE YOU ENTER ANY EXERCISE PROGRAM. FOR YOUR OWN SAFETY, DO NOT BEGIN ANY EXERCISE WITHOUT PROPER INSTRUCTION.

SBP-100G CHEST PRESS

